



TECHNICAL NOTES on Brick Construction

1850 Centennial Park Drive, Suite 301, Reston VA 20191 | www.gobrick.com | 703-620-0010

Technical Notes 31 - Brick Masonry Arches January 1995

Abstract: The masonry arch is one of the oldest structural elements. Brick masonry arches have been used for hundreds of years. This *Technical Notes* is an introduction to brick masonry arches. Many of the different types of brick masonry arches are discussed and a glossary of arch terms is provided. Material selection, proper construction methods, detailing and arch construction recommendations are discussed to ensure proper structural support, durability and weather resistance of the brick masonry arch.

Key Words: arch, brick, reinforced, unreinforced.

INTRODUCTION

In the latter part of the 19th century, an arch was discovered in the ruins of Babylonia. Archeologists estimate that the arch was constructed about the year 1400 B.C. Built of well-baked, cigar-shaped brick and laid with clay mortar, this arch is probably the oldest known to man. The Chinese, Egyptians and others also made use of the arch before the Christian era. Later, more elaborate arches, vaults and domes with complicated forms and intersections were constructed by Roman builders during the Middle Ages.

The brick arch is the consummate example of form following function. Its aesthetic appeal lies in the variety of forms which can be used to express unity, balance, proportion, scale and character. Its structural advantage results from the fact that under uniform load, the induced stresses are principally compressive. Because brick masonry has greater resistance to compression than tension, the masonry arch is frequently the most efficient structural element to span openings.

This *Technical Notes* addresses the detailing and construction of brick masonry arches. The common types of brick masonry arches are presented, along with proper arch terminology. Methods of selecting the type and configuration of brick masonry arches most appropriate for the application are discussed. Proper material selection and construction methods are recommended. Other *Technical Notes* in this series discuss the structural design of brick masonry arches and lintels.

ARCH TYPES AND TERMINOLOGY

Many arch forms have been developed during the centuries of use, ranging from the jack arch through the circular, elliptical and parabolic to the Gothic arch. Figure 1 depicts examples of structural masonry arches used in contemporary construction. An arch is normally classified by the curve of its intrados and by its function, shape or architectural style. Figure 2 illustrates some of the many different brick masonry arch types. Jack, segmental, semicircular and multicentered arches are the most common types used for building arches. For very long spans and for bridges, semicircular arches are often used because of their structural efficiency.

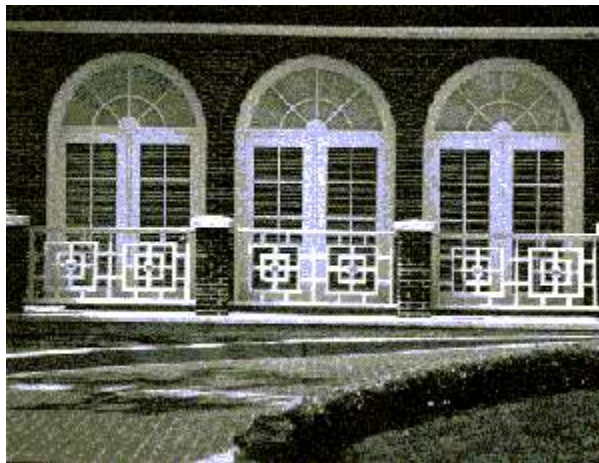

Structural Brick Arches

FIG. 1

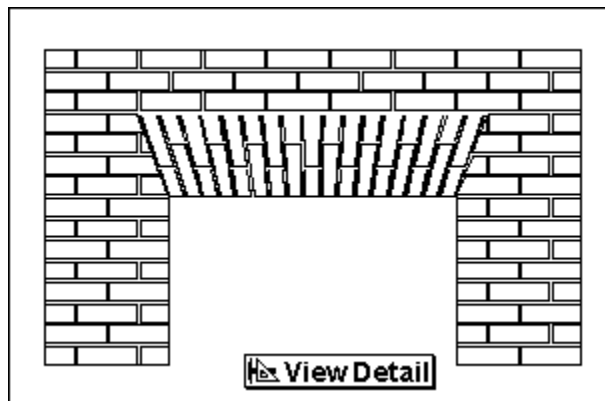

Arch Types: Jack

FIG. 2a

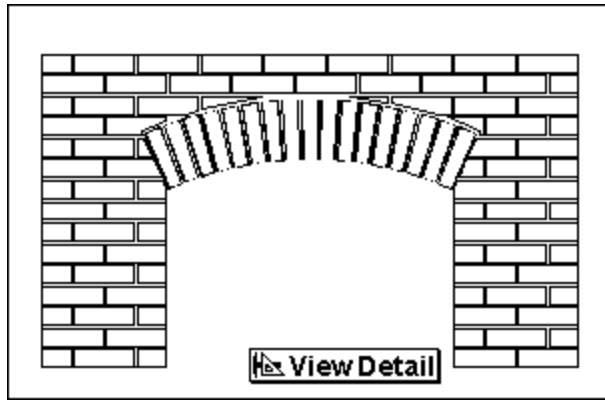

Arch Types: Segmental

FIG. 2b

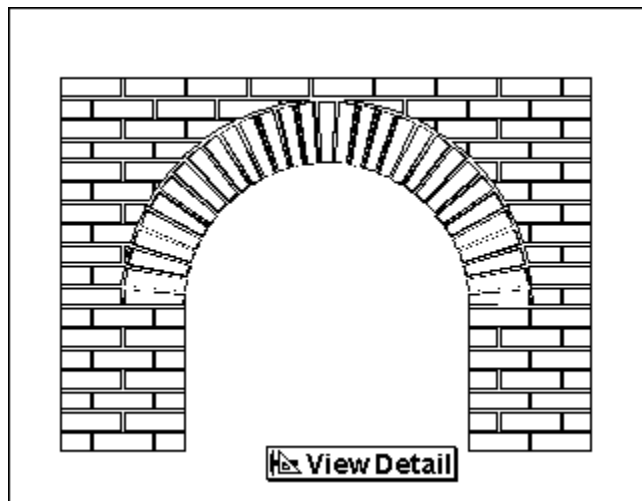

Arch Types: Semicircular

FIG. 2c

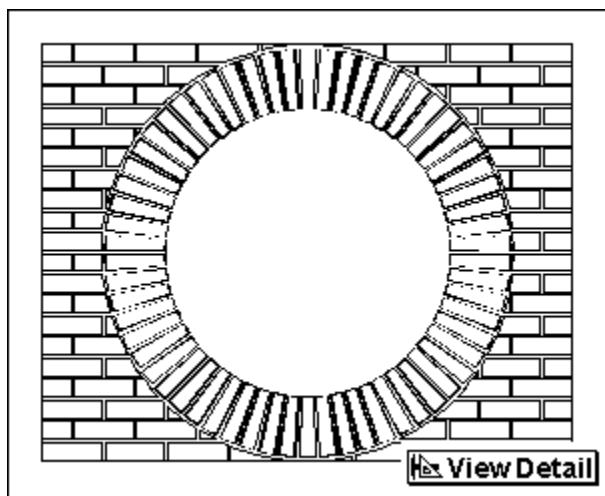

Arch Types: Bullseye

FIG. 2d

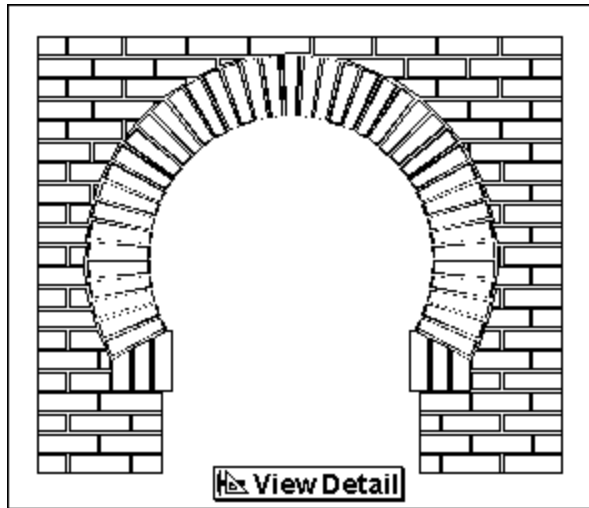

Arch Types: Horseshoe

FIG. 2e

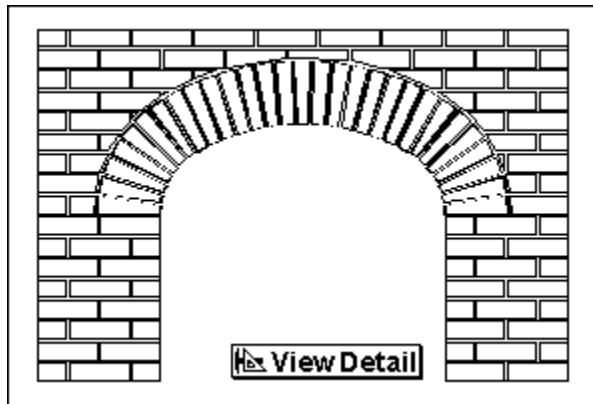

Arch Types: Multicentered

FIG. 2f

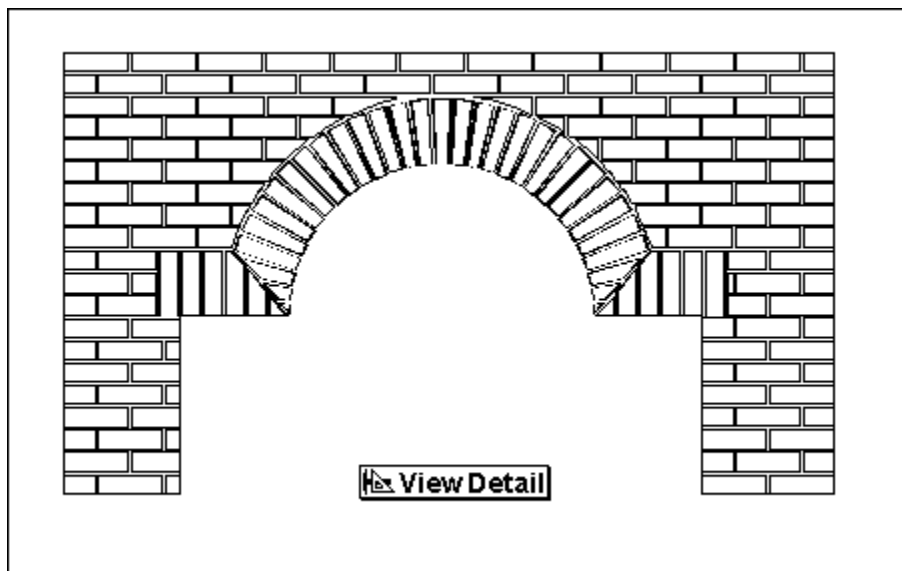

Arch Types: Venetian

FIG. 2g

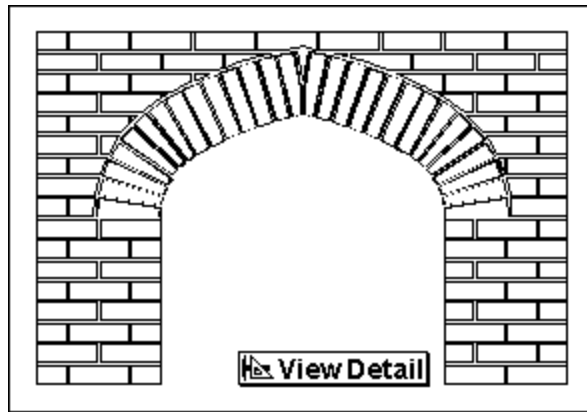

Arch Types: Tudor

FIG. 2h

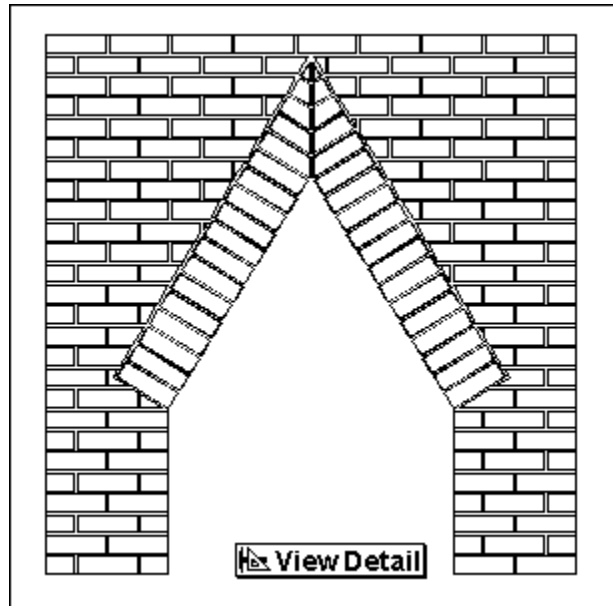

Arch Types: Triangular

FIG. 2i

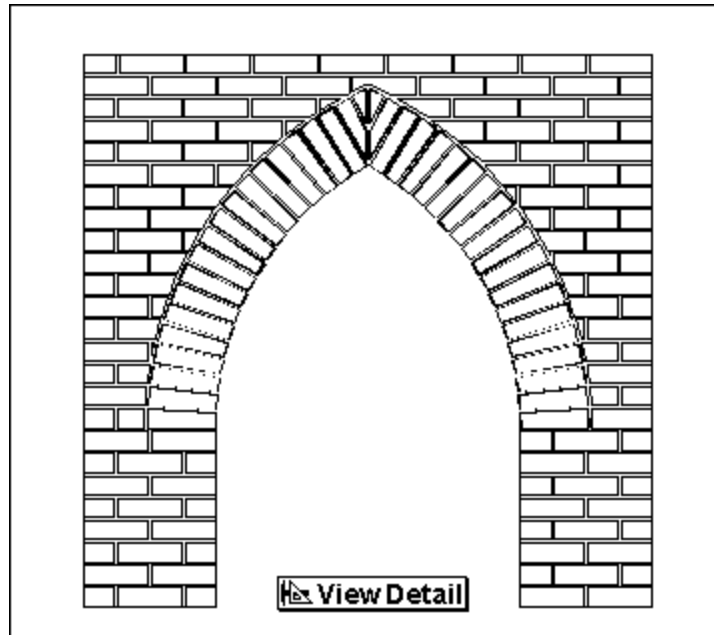

Arch Types: Gothic

FIG. 2j

Mainly due to their variety of components and elements, arches have developed their own set of terminology. Following is a glossary of arch terminology. Figure 3 illustrates many of the terms defined in this glossary. *Technical Notes* in this series will use this terminology.

Abutment: The masonry or combination of masonry and other structural members which support one end of the arch at the skewback.

Arch: A form of construction in which masonry units span an opening by transferring vertical loads laterally to adjacent voussoirs and, thus, to the abutments. Some common arch types are as follows:

Blind -An arch whose opening is filled with masonry.

Bullseye -An arch whose intrados is a full circle. Also known as a *Circular* arch.

Elliptical -An arch with two centers and continually changing radii.

Fixed -An arch whose skewback is fixed in position and inclination. Masonry arches are fixed arches by nature of their construction.

Gauged -An arch formed with tapered voussoirs and thin mortar joints.

Gothic -An arch with relatively large rise-to-span ratio, whose sides consist of arcs of circles, the centers of which are at the level of the spring line. Also referred to as a *Drop*, *Equilateral* or *Lancet* arch, depending upon whether the spacings of the centers are respectively less than, equal to or more than the clear span.

Horseshoe -An arch whose intrados is greater than a semicircle and less than a full circle. Also known as an *Arabic* or *Moorish* arch.

Jack -A flat arch with zero or little rise.

Multicentered -An arch whose curve consists of several arcs of circles which are normally tangent at their intersections.

Relieving -An arch built over a lintel, jack arch or smaller arch to divert loads, thus relieving the lower arch or lintel from excessive loading. Also known as a *Discharging* or *Safety* arch.

Segmental -An arch whose intrados is circular but less than a semicircle.

Semicircular -An arch whose intrados is a semicircle (half circle).

Slanted -A flat arch which is constructed with a keystone whose sides are sloped at the same angle as the skewback and uniform width brick and mortar joints.

Triangular -An arch formed by two straight, inclined sides.

Tudor -A pointed, four-centered arch of medium rise-to-span ratio whose four centers are all beneath the extrados of the arch.

Venetian -An arch formed by a combination of jack arch at the ends and semicircular arch at the middle. Also known as a *Queen Anne* arch.

Camber: The relatively small rise of a jack arch.

Centering: Temporary shoring used to support an arch until the arch becomes self-supporting.

Crown: The apex of the arch's extrados. In symmetrical arches, the crown is at the midspan.

Depth: The dimension of the arch at the skewback which is perpendicular to the arch axis, except that the depth of a jack arch is taken to be the vertical dimension of the arch at the springing.

Extrados: The curve which bounds the upper edge of the arch.

Intrados: The curve which bounds the lower edge of the arch. The distinction between soffit and intrados is that the intrados is a line, while the soffit is a surface.

Keystone: The voussoir located at the crown of the arch. Also called the *key*.

Label Course: A ring of projecting brickwork that forms the extrados of the arch.

Rise: The maximum height of the arch soffit above the level of its spring line.

Skewback: The surface on which the arch joins the supporting abutment.

Skewback Angle: The angle made by the skewback from horizontal.

Soffit: The surface of an arch or vault at the intrados.

Span: The horizontal clear dimension between abutments.

Spandrel: The masonry contained between a horizontal line drawn through the crown and a vertical line drawn through the upper most point of the skewback.

Springing: The point where the skewback intersects the intrados.

Springer: The first voussoir from a skewback.

Spring Line: A horizontal line which intersects the springing.

Voussoir: One masonry unit of an arch.

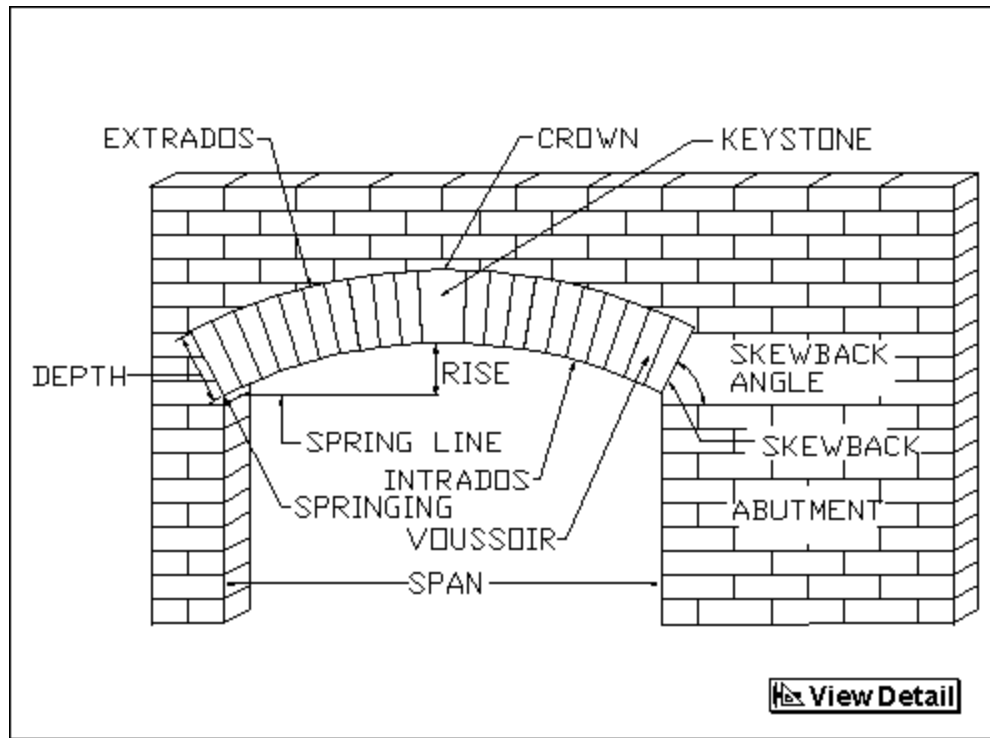

Arch Terms

FIG. 3

STRUCTURAL FUNCTION OF ARCHES

The brick masonry arch has been used to span openings of considerable length in many different applications. Structural efficiency is attributed to the curvature of the arch, which transfers vertical loads laterally along the arch to the abutments at each end. The transfer of vertical forces gives rise to both horizontal and vertical reactions at the abutments. The curvature of the arch and the restraint of the arch by the abutments cause a combination of flexural stress and axial compression. The arch depth, rise and configuration can be manipulated to keep stresses primarily compressive. Brick masonry is very strong in compression, so brick masonry arches can support considerable load.

Historically, arches have been constructed with unreinforced masonry. Most brick masonry arches continue to be built with unreinforced masonry. The structural design of unreinforced brick masonry arches is discussed in *Technical Notes 31A*. Very long span arches and arches with a small rise may require steel reinforcement to resist tensile stresses. Also, reduction in abutment size and arch thickness for economy may require incorporation of reinforcement for adequate load resistance. Refer to the *Technical Notes 17 Series* for more information on reinforced brick masonry. Elaborate and intricate arches are sometimes prefabricated to avoid the complexity of on-site shoring. Most prefabricated brick masonry arches are reinforced. Prefabricated arches are built off site and transported to the job or built at the site. Cranes are often used to lift the arch into place in the wall. Such fabrication, handling and transportation should be considered in the structural design of the arch. Refer to *Technical Notes 40* for a discussion of prefabricated brick masonry.

If an unreinforced or reinforced brick masonry arch is not structurally adequate, the arch will require support. Typically, this support is provided by a steel angle. This is the most common means of supporting brick masonry arches in modern construction. The steel angle is bent to the curvature of the intrados of the arch. Curved sections of steel angle are welded to horizontal steel angles to form a continuous support. The angle either bears on the brickwork abutments or is attached to a structural member behind the wall. One example is shown in Fig. 4. When an arch is supported by a steel angle, the angle is designed to support the entire weight of brick masonry loading the arch, and the structural resistance of the arch is neglected. Consult *Technical Notes 31B Revised* for a discussion of the structural design of steel angle lintels.

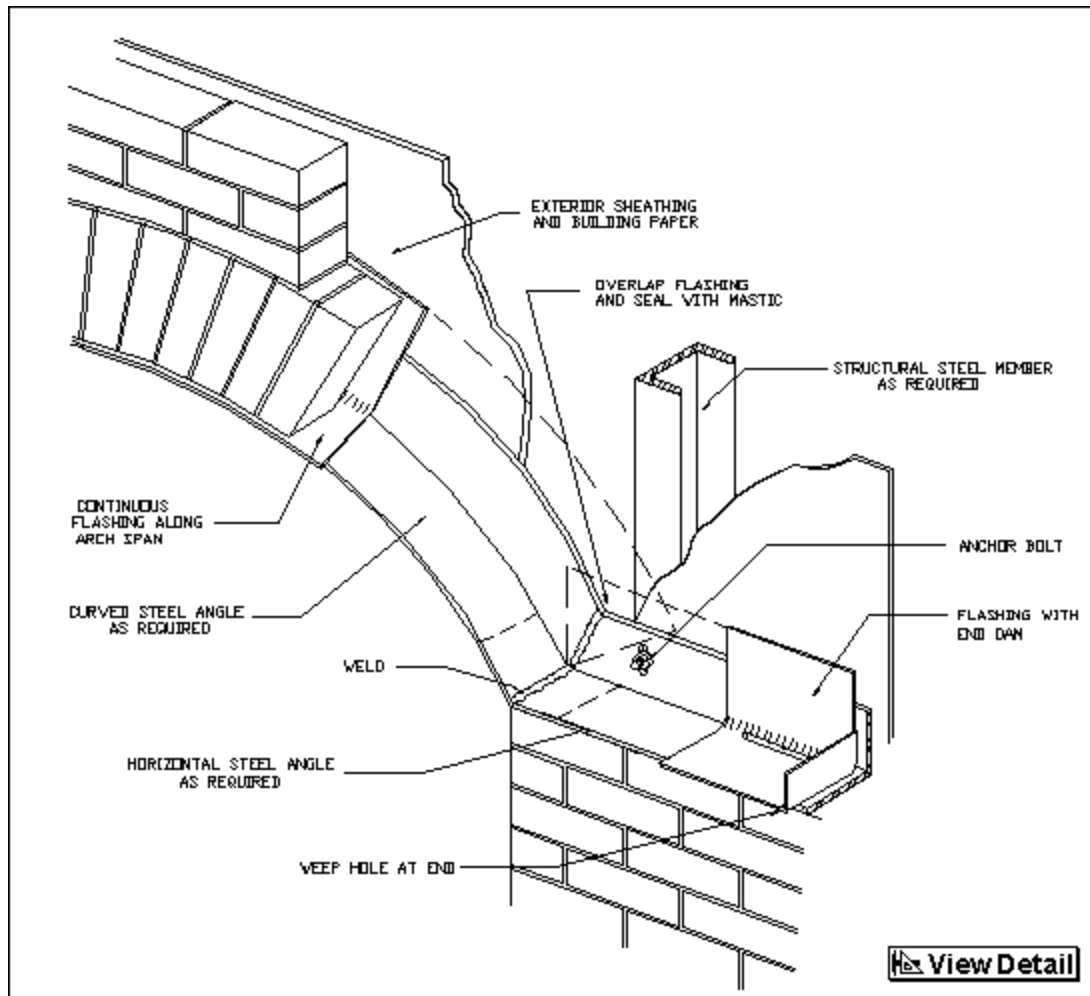

Arch Supported by Curved Steel Angle

FIG. 4

WEATHER RESISTANCE

Water penetration resistance is a primary concern in most applications of the building arch. In the past, the mass of a multi-wythe brick masonry arch was sufficient to resist water penetration. Today, thinner wall sections are used to minimize material use for economy and efficiency. Still, the arch must provide an effective weather resistant facade. Some arch applications do not require provisions for water penetration and insulation. For example, arch arcades and arches supported by porch columns typically do not conceal a direct path for water migration to the interior of the building they serve and may not require insulation. If this is the case, provisions for weather resistance need not be included in the arch design and detailing.

Preventing water entry at an arch in an exterior building wall is just as important as at any other wall opening. Water penetration resistance can be provided by using a barrier wall system or a drainage wall system. Refer to *Technical Notes 7 Revised* for definitions and discussion of barrier and drainage wall systems. A drainage wall system, such as a brick veneer or cavity wall, is the most common brick masonry wall system used today. For either wall system, the arch should be flashed, with weep holes provided above all flashing locations.

Flashing and Weep Holes

Installation of flashing and weep holes around an arch can be difficult. Installation of flashing is easiest with jack arches because they are flat or nearly flat. Flashing should be installed below the arch and above the window framing or steel angle lintel. Flashing should extend a minimum of 4 in. (100 mm) past the wall opening at either end and should be turned up to form end dams. This is often termed tray flashing. Weep holes should be provided at both ends of the flashing and should be placed at a maximum spacing of 24 in. (600 mm) on centers along the

arch span, or 16 in. (400 mm) if rope wicks are used. An example of flashing a jack arch in this manner is shown in Fig. 5a. Attachment of the flashing to the backing and formation of end dams should follow standard procedures. If the arch is constructed with reinforced brick masonry, flashing and weep holes can be placed in the first masonry course above the arch.

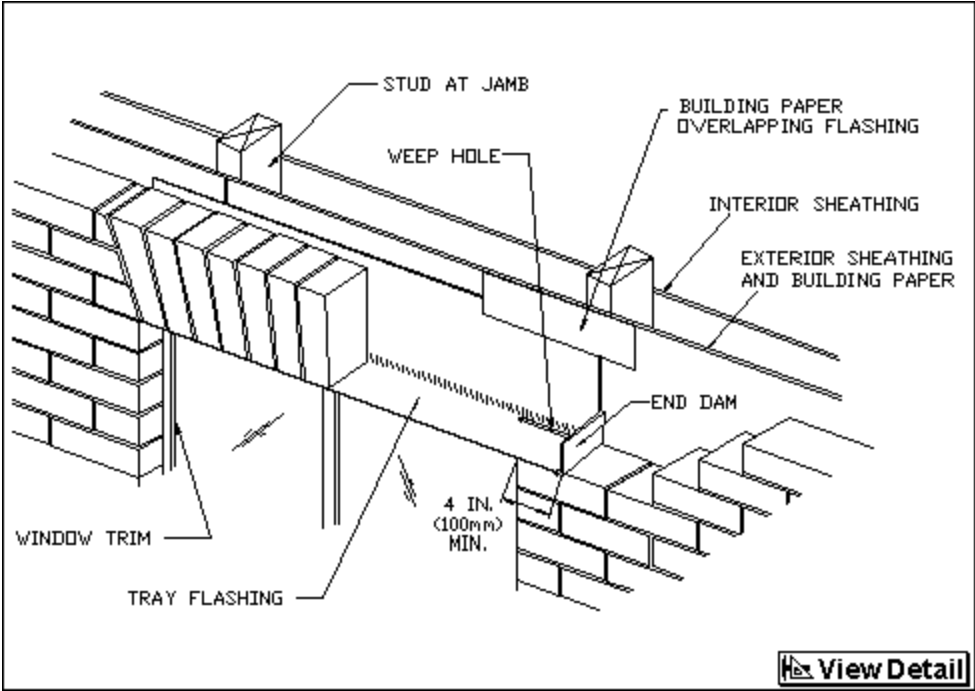

Flashing Arches

FIG. 5a

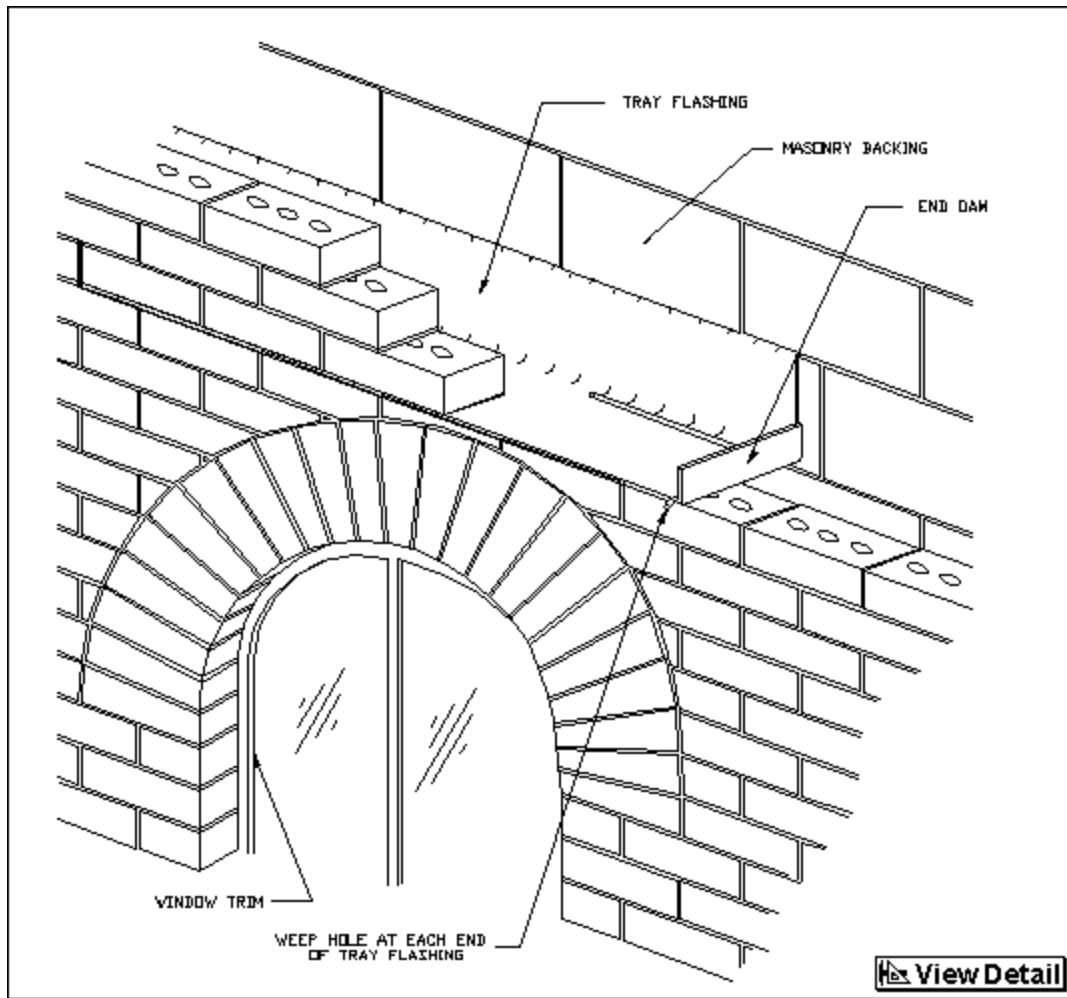

Flashing Arches

FIG. 5b

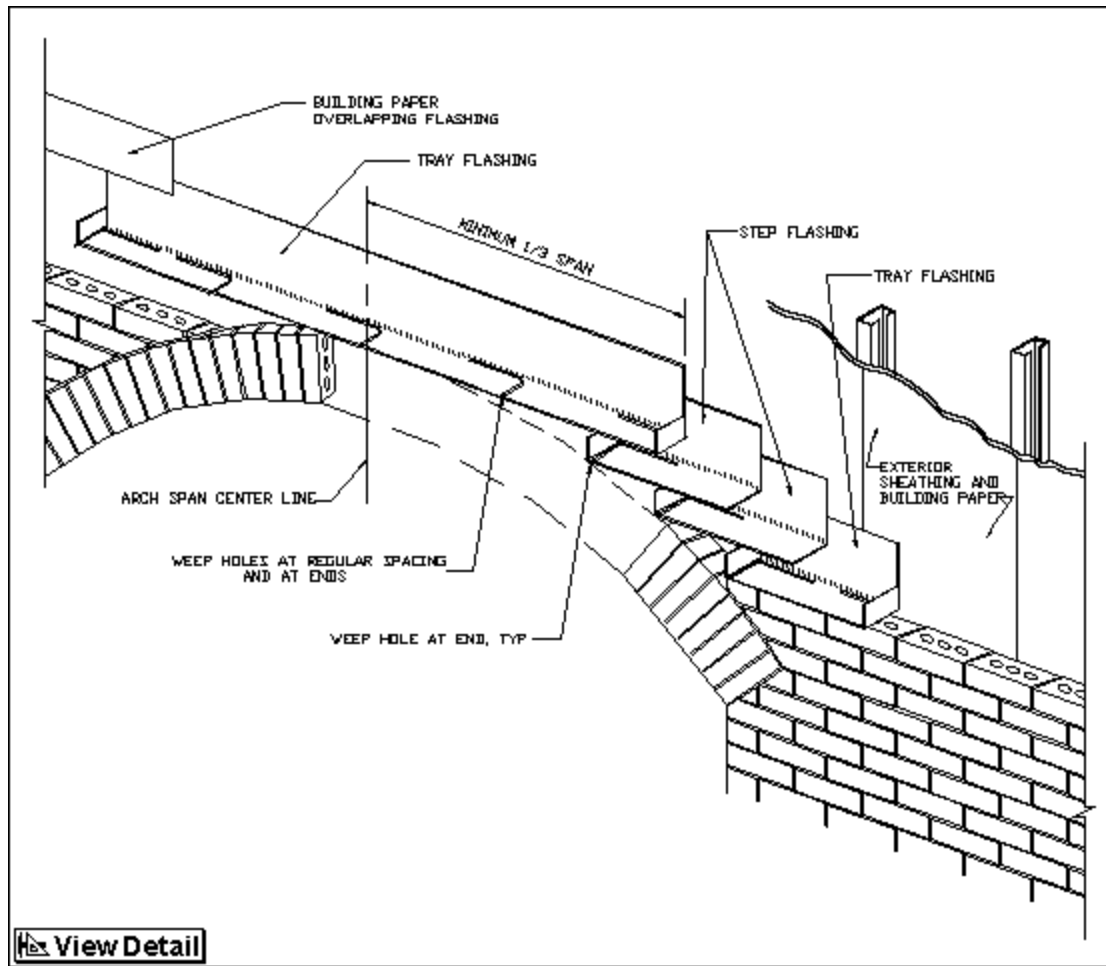

Flashing Arches

FIG. 5c

Installation of flashing with other arch types, such as segmental and semicircular arches, can be more difficult. This is because most rigid flashing materials are hard to bend around an arch with tight curvature. If the arch span is less than about 3 ft (0.9 m), one section of tray flashing can be placed in the first horizontal mortar joint above the keystone, as illustrated in Fig. 5b. For arch spans greater than 3 ft (0.9 m), flashing can be bent along the curve of the arch with overlapping sections, as illustrated in Fig. 4. Alternately, a combination of stepped and tray flashing can be used, as shown in Fig. 5c. To form a step, the end nearest the arch should be turned up to form an end dam, while the opposite end is laid flat. A minimum of No. 15 building paper or equivalent moisture resistant protection should be installed on the exterior face of the backing over the full height of the arch and abutments. The building paper or equivalent should overlap the arch flashing.

The design of a structural masonry arch should include consideration of the effect of flashing on the strength of the arch. Flashing acts as a bond break. If flashing is installed above the arch, the loading on the arch will likely be increased, and the structural resistance of the arch will be reduced. Installation of flashing at the abutments will affect their structural resistance and should also be considered. Consult *Technical Notes 31A* for a more extensive discussion of arch loads and structural resistance of brick masonry arches.

DETAILING CONSIDERATIONS

The brick masonry arch should serve its structural purpose and also provide an attractive architectural element to complement its surrounding structure. Careful consideration should be given to the options available for the arch, soffit and skewback. Proper configuration of the abutments and location of expansion joints should be considered for any arch design.

Arch

Arches can be configured in a variety of arch depths, brick sizes and shapes and bonding patterns. The arch is normally composed of an odd number of units for aesthetic purposes. Some of the more common arch configurations are illustrated in Fig. 6. Arch voussoirs are typically laid in radial orientation and are most often of similar size and color to the surrounding brickwork. However, the arch can be formed with brick which are thinner or wider than the surrounding brickwork and of a different color for variation. Another variation is to project or recess rings of multiple-ring arches to provide shadow lines or a label course.

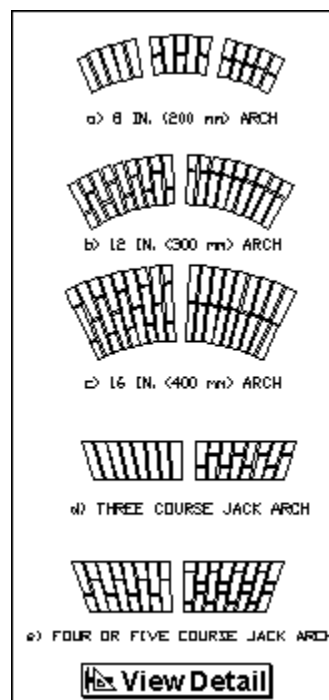

Typical Arch Configurations

FIG. 6

Brick masonry arches are constructed with two different types of units. The first is tapered or wedge-shaped brick. These bricks are tapered in the appropriate manner to obtain mortar joints of uniform thickness along the arch depth. The second is uncut, rectangular brick. When rectangular bricks are used, the mortar joints are tapered to obtain the desired arch curvature. In some cases, a combination of these is used. For example, a slanted arch is formed with a tapered keystone and rectangular brick. This arch is similar to a jack arch, but can be more economical because it requires only one special-shaped brick.

Selection of tapered or rectangular brick can be determined by the arch type, arch dimensions and by the appearance desired. Some arch types require more unique shapes and sizes of brick if uniform mortar joint thickness is desired. For example, the bricks in a traditional jack arch or elliptical arch are all different sizes and shapes from the abutment to the keystone. Conversely, the voussoirs of a semicircular arch are all the same size and shape. Arch types with many different brick shapes and sizes should be special ordered from the brick manufacturer rather than cut in the field.

The arch span should also be considered when selecting the arch brick. For short arch spans, use of tapered brick is recommended to avoid excessively wide mortar joints at the extrados. Larger span arches require less taper of the voussoirs and, consequently, can be formed with rectangular brick and tapered mortar joints. The thickness of mortar joints between arch bricks should be a maximum of 3/4 in. (19 mm) and a minimum of 1/8 in. (3 mm). When using mortar joints thinner than 1/4 in. (6 mm), consideration should be given to the use of very uniform brick that meet the dimensional tolerance limits of ASTM C 216, Type FBX, or the use of gauged brickwork. Refer to Table 1 for determination of the minimum segmental and semicircular arch radii permitted for rectangular brick and tapered mortar joints. Typically, the use of tapered brick and uniform thickness mortar joints will be more aesthetically appealing.

TABLE 1
Minimum Radius for Uncut Arch Brick^{1,2}

Nominal Face Dimensions of Arch Brick, in. (height by width)	Minimum Permissible Radius of Arch to Intrados, ft
4 x 2-2/3	3.3
8 x 2-2/3	6.7
12 x 2-2/3	10.0
16 x 2-2/3	13.3
4 x 3-1/5	4.0
8 x 3-1/5	8.0
12 x 3-1/5	12.0
16 x 3-1/5	16.0
4 x 4	5.2
8 x 4	10.3
12 x 4	15.5
16 x 4	20.7

¹Based on 1/4 in. (6 mm) mortar joint width at the intrados and 1/2 in. (13 mm) mortar joint width at the extrados. If the mortar joint thickness at the extrados is 3/4 in. (19 mm), divide minimum radius value by 2.

²1 in.=25.4 mm; 1 ft=0.3m

Depth. The arch depth will depend upon the size and orientation of the brick used to form the arch. Typically, the arch depth is a multiple of the brick's width. For structural arches, a minimum arch depth is determined from the structural requirements. If the arch is supported by a lintel, any arch depth may be used.

The depth of the arch should also be detailed based on the scale of the arch in relation to the scale of the building and surrounding brickwork. To provide proper visual balance and scale, the arch depth should increase with increasing arch span. Because aesthetics of an arch are subjective, there are no hard rules for this. However, the following rules-of-thumb will help provide an arch with proper scale. For segmental and semicircular arches, the arch depth should equal or exceed 1 in. (25 mm) for every foot (300 mm) of arch span or 4 in. (100 mm), whichever is greater. For jack arches, the arch depth should equal or exceed 4 in. (100 mm) plus 1 in. (25 mm) for every foot (300 mm) of arch span or 8 in. (200 mm), whichever is greater. For example, the minimum arch depth for an 8 ft (2.4 m) span should be 8 in. (200 mm) for segmental arches and 12 in. (300 mm) for jack arches.

The depth of jack arches will also be a function of the coursing of the surrounding brick masonry. The springing and the extrados of the jack arch should coincide with horizontal mortar joints in the surrounding brick masonry. Typically, the depth of a jack arch will equal the height of 3, 4 or 5 courses of the surrounding brickwork, depending upon the course height.

Keystone. The keystone may be a single brick, multiple brick, stone, precast concrete or terra cotta. Avoid using a keystone which is much taller than the adjacent voussoirs. A rule-of-thumb is that the keystone should not extend above adjacent arch brick by more than one third the arch depth. When a keystone is used that is larger than adjacent arch brick or formed with different material, one option is to use springers that match the keystone.

The use of a large keystone has its basis in both purpose and visual effect. With most arch types, the likely location of the first crack when the arch fails is at the mortar joint nearest to the midspan of the arch. Use of a large keystone at this point moves the first mortar joint further from the midspan and increases the resistance to cracking at this point. Aesthetically, a large keystone adds variation of scale and can introduce other masonry materials in the facade for additional color and texture.

If the keystone is formed with more than one masonry unit, avoid placing the smaller unit at the bottom. Such units are more likely to slip when the arch settles under load. Also, it is preferred to have the arch crown (the top of the keystone) coincident with a horizontal mortar joint in the surrounding brickwork to give the arch a neater appearance.

Soffit

A brick masonry soffit is one attractive feature of a structural brick masonry arch. Many bonding patterns and arrangements can be used to form the arch soffit. Deep soffits are common on building arcades or arched entranceways. In this case, it is common to form a U-shaped wall section, as illustrated in Fig. 7. The arches on either wall face should be bonded to the brick masonry forming the soffit. Bonding pattern or metal ties should be used to tie the brick masonry forming the soffit together structurally and to tie the arches on either wall face to the soffit. If metal ties are used to bond the masonry, corrosion resistant box or Z metal wire ties should be placed along the arch span at a maximum spacing of 24 in. (600 mm) on center.

Structural resistance of the arch should be evaluated at sections through the soffit, the exterior wall face and the interior wall face. Deeper soffits may require an increase in arch depth. If the arch is structural, connection of the brick masonry forming the soffit to interior framing members with wall ties or connectors may not be required.

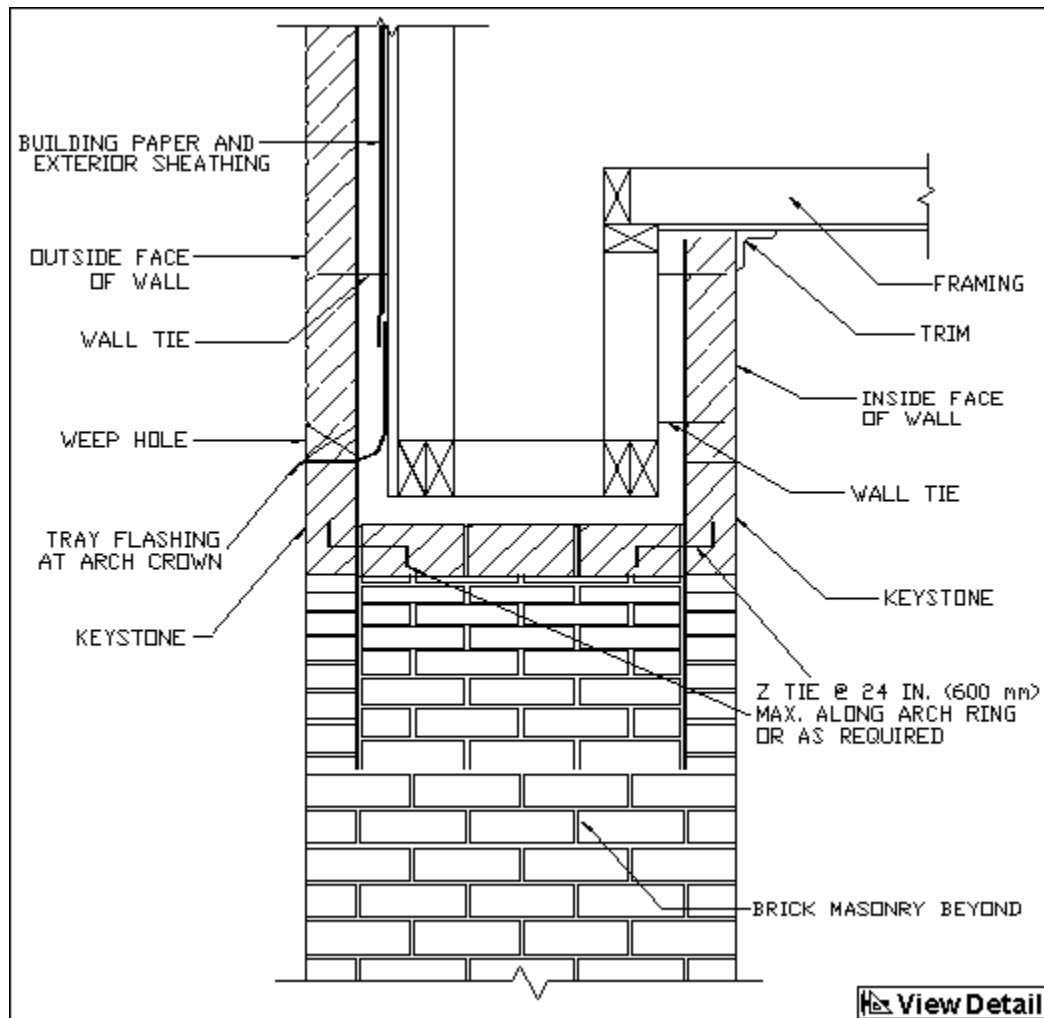

Structural Arch Soffit Option

FIG. 7

Skewback

For flat arches and arch types that have horizontal skewbacks, such as jack and semicircular arches, respectively, the most desirable spring line location is coincident with a bed joint in the abutment. For other arch types, it is preferred to have the spring line pass about midway through a brick course in the abutment, as illustrated in Fig. 8, to avoid a thick mortar joint at the springing. The brick in the abutment at the springing should be cut or be a special cant-shaped brick. This allows vertical alignment with the brick beneath, producing more accurate alignment of the arch.

When two arches are adjacent, such as with a two-bay garage or building arcades, intersection of the arches may occur at the skewback. Attention should be given to proper bonding of the arches for both visual appeal and structural bonding. Creation of a vertical line between arches should be avoided. Rather, special shape brick should be used to mesh the two arches properly. One example is illustrated in Fig. 9.

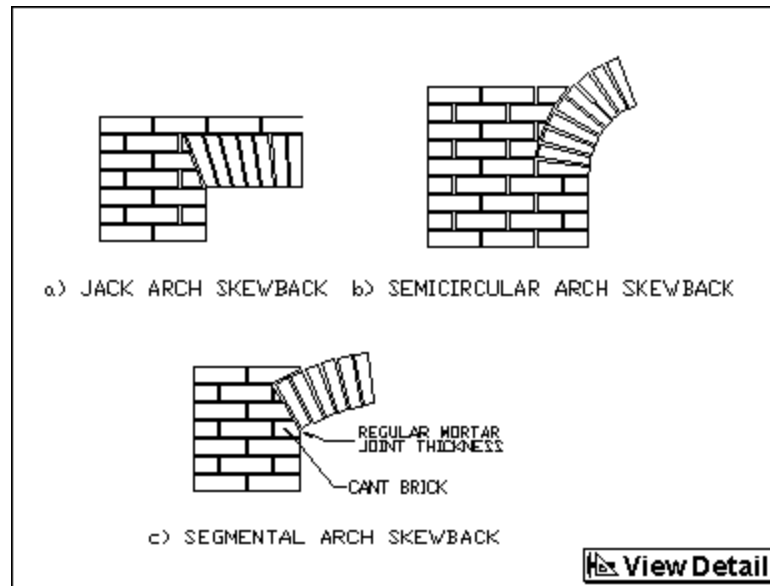

Skewback Options

FIG. 8

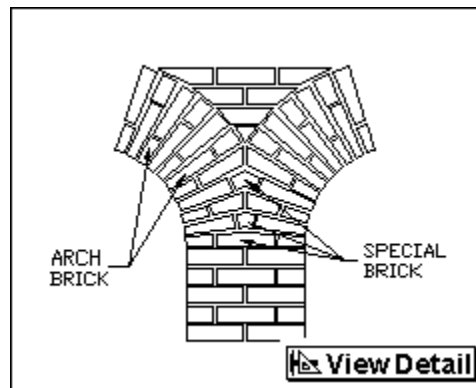

Option For Intersecting Arches

FIG. 9

Abutments

An arch abutment can be a column, wall or combination of wall and shelf angle. Failure of an abutment occurs from excessive lateral movement of the abutment or exceeding the flexural, compressive or shear strength of the abutment. Lateral movement of the abutment is due to the horizontal thrust of the arch. Thrust develops in all arches and the thrust force is greater for flatter arches. The thrust should be resisted so that lateral movement of the abutment does not cause failure in the arch. If the abutment is formed by a combination of brickwork and a non-masonry structural member, rigidity of the non-masonry structural member and rigidity of the ties are very important. Adjustable ties or single or double wire ties are recommended. Corrugated ties should not be used in this application because they do not provide adequate axial stiffness. Consult *Technical Notes 31A* for further discussion of abutment and tie stiffness requirements.

Lateral Bracing

In addition to gravity loads, out-of-plane loads should be considered when designing a masonry arch. The arch should have adequate resistance to out-of-plane loads or lateral bracing should be provided. In veneer construction, lateral bracing is provided by the backing through the use of wall ties. Arches which are not laterally braced may require increased masonry thickness or reinforcement to carry loads perpendicular to the arch plane in addition to vertical loads.

Expansion Joints

Thermal and moisture movements of brick masonry are controlled by the use of expansion joints. Expansion joints avoid cracking of the brickwork and also reduce the size of wall sections. Reduction of wall size has a very important effect upon the performance of structural brick masonry arches. The state of stress in a structural brick arch and the surrounding masonry is very sensitive to the relative movements of the abutments. If an inadequate number of expansion joints are provided, the differential movement of abutments can cause cracking and downward displacement of brick in the masonry arch and surrounding masonry. Proper size and spacing of expansion joints is discussed in *Technical Notes 18A Revised*.

If the arch is structural, care should be taken not to affect the integrity of the arch by detailing expansion joints too close to the arch and its abutments. Vertical expansion joints should not be placed in the masonry directly above a structural arch. This region of masonry is in compression, so an expansion joint will cause displacement when centering is removed and possible collapse of the arch and surrounding brickwork. In addition, vertical expansion joints should not be placed in close proximity to the springing. The expansion joint will reduce the effective width of the abutment and its ability to resist horizontal thrust from the arch. If the arch is non-structural, placement of expansion joints may be at the arch crown and also at a sufficient distance away from the springing to avoid sliding. While permitted, placement of an expansion joint at the arch crown is not preferred because it disrupts one's traditional view of the arch as a structural element. Refer to Fig. 10 for suggested expansion joint locations for structural and non-structural arches.

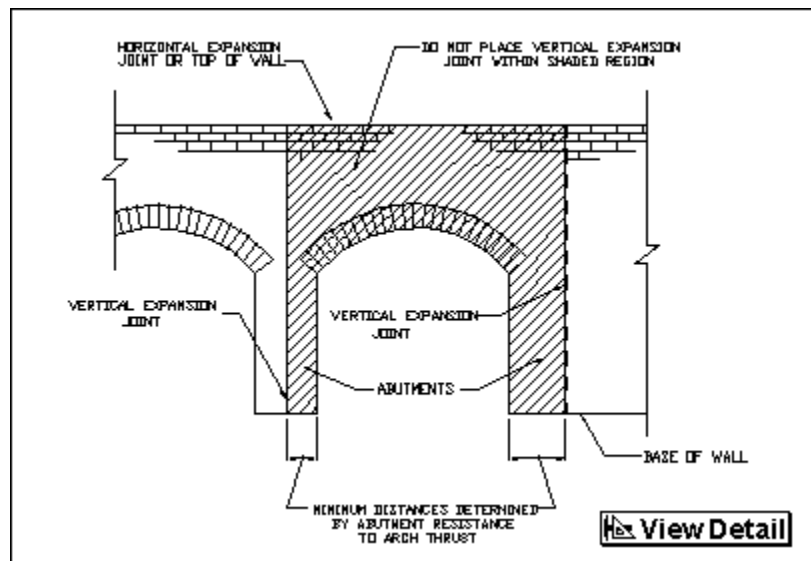

Expansion Joints Near Arches

FIG. 10a

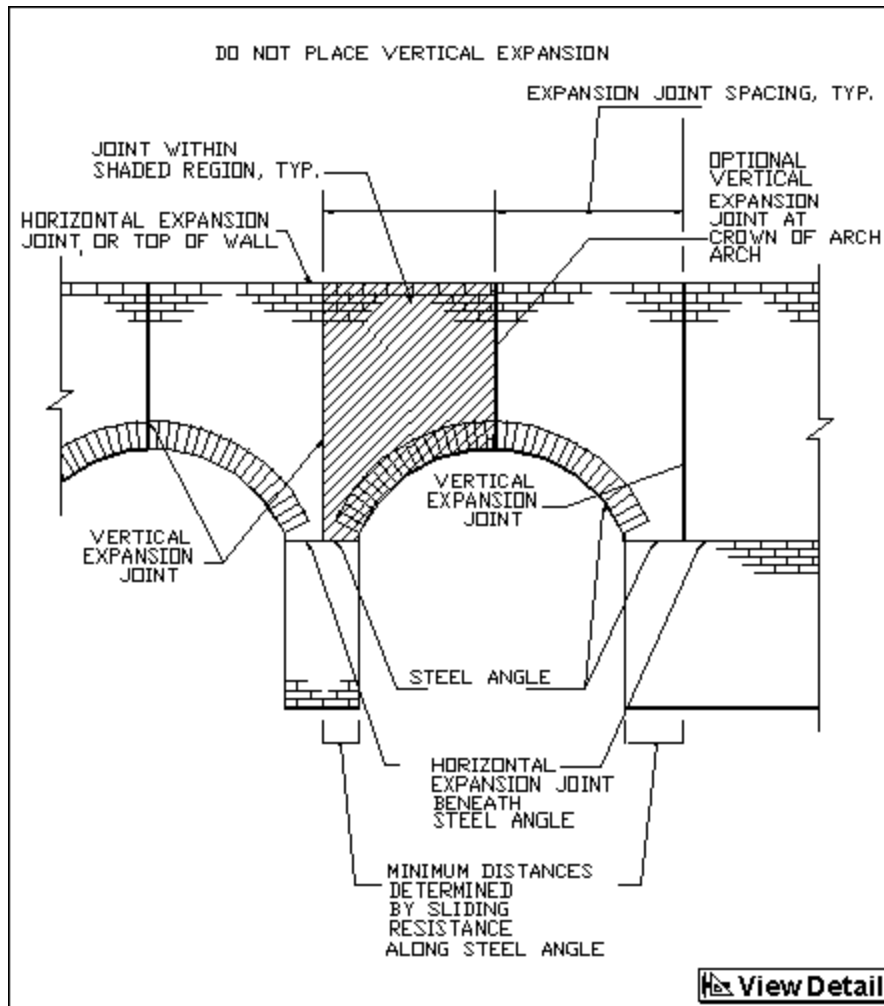

Expansion Joints Near Arches

FIG. 10b

Detailing of expansion joints can be difficult with very long span arches or runs of multiple arches along an arcade. Structural analysis of the arch should consider the location of expansion joints. For the particular case of multiple arches closely spaced, vertical expansion joints should be detailed at a sufficient distance away from the end arches so that horizontal arch thrusts are adequately resisted by the abutments to avoid overturning of the abutments. For long arcades, expansion joints should also be placed along the centerline of abutments between arches when necessary. In this case, horizontal thrusts from adjacent arches will not be counteracting, so the effective abutment length should be halved and overturning of each half of the abutment should be checked. Refer to *Technical Notes* 31A for further discussion of abutment design for adequate stiffness.

MATERIAL SELECTION

To provide a weather resistant barrier and maintain its structural resistance, the arch must be constructed with durable materials. The strength of an arch depends upon the compressive strength and the flexural tensile strength of the masonry. Selection of brick and mortar should consider these properties.

Brick

Solid or hollow clay brick may be used to form the arch and the surrounding brickwork. Solid brick should comply with the requirements of ASTM C 216 Specification for Facing Brick. Hollow brick should comply with the requirements of ASTM C 652 Specification for Hollow Brick. Refer to *Technical Notes* 9 Series for a discussion of brick selection and classification. The compressive strength of masonry is related to the compressive strength of the brick, the mortar type and the grout strength. For structural arches, brick should be selected with

consideration of the required compressive strength of masonry. Typically, compressive strength of the brick masonry will not limit the design of the arch.

Tapered voussoirs can be cut from rectangular units at the job site or special ordered from the brick manufacturer. Before specifying manufactured special arch shapes, the designer should determine the availability of special shapes for the arch type and brick color and texture desired. Many brick manufacturers produce tapered arch brick for the more common arch types as part of their regular stock of special shapes. Be sure to contact the manufacturer as early as possible if special shapes are needed. In many instances, production of the special shapes may require a color matching process and adequate lead time for the manufacturer.

Mortar

Mortar used to construct brick masonry arches should meet the requirements of ASTM C 270 Standard Specification for Masonry Mortar. Consult *Technical Notes 8 Series* for a discussion of mortar types and kinds for brick masonry. For structural arches, the flexural tensile strength of the masonry should be considered when selecting the mortar. The flexural tensile strength of the masonry will affect the load resistance of the arch and the abutments.

CONSTRUCTION AND WORKMANSHIP

The proper performance of a brick masonry arch depends upon proper methods of construction and attention to workmanship. Layout of the arch prior to construction will help avoid poor spacing of voussoirs, which results in thicker mortar joints and unsymmetrical arches. Some arch applications, such as barrel vaults and domes, can be entirely self-supporting, even during construction. However, most applications of the masonry arch used today require proper shoring and bracing.

Centering

Both structural and non-structural arches should be properly supported throughout construction. Brick masonry arches are constructed with the aid of temporary shoring, termed centering, or permanent supports, such as a structural steel angle.

Centering is used to carry the weight of a brick masonry arch and the loads being supported by the arch until the arch itself has gained sufficient strength. The term "centering" is used because the shoring is marked for proper positioning of the brick forming the arch. Centering is typically provided by wood construction. An example of centering for an arch is shown in Fig. 11. Careful construction of the centering will ensure a more pleasing arch appearance and avoid layout problems, such as an uneven number of brick to either side of the keystone.



Centering

FIG. 11

Immediately after placement of the keystone, very slight downward displacement of the centering, termed easing, can be performed to cause the arch voussoirs to press against one another and compress the mortar joints between them. Easing helps to avoid separation cracks in the arch. In no case should centering be removed until it is certain that the masonry is capable of carrying all imposed loads. Premature removal of the centering may result in collapse of the arch.

Centering should remain in place for at least seven days after construction of the arch. Longer curing periods may be required when the arch is constructed in cold weather conditions and when required for structural reasons. The arch loading and the structural resistance of the arch will depend upon the amount of brickwork surrounding the arch, particularly the brick masonry within spandrel areas. Appropriate time of removal of centering for a structural arch should be determined with consideration of the assumptions made in the structural analysis of the arch. It may be necessary to wait until the brickwork above the arch has also cured before removing the centering.

Workmanship

All mortar joints should be completely filled, especially in a structural member such as an arch. If hollow brick are used to form the arch, it is very important that all face shells and end webs are completely filled with mortar. Brick masonry arches are sometimes constructed with the units laid in a soldier orientation. It may be difficult to lay units in a soldier position and also obtain completely filled mortar joints. This is especially true for an arch with tapered mortar joints. In such cases, the use of two or more rings of arch brick laid in rowlock orientation can help ensure full mortar joints.

SUMMARY

This *Technical Notes* is an introduction to brick masonry arches. A glossary of arch terms has been provided. Many different types of brick masonry arches are described and illustrated. Proper detailing of brick masonry arches for appearance, structural support and weather resistance is discussed. Material selection and proper construction practices are explained. Other *Technical Notes* in this Series discuss the structural design of arches.

The information and suggestions contained in this *Technical Notes* are based on the available data and the experience of the engineering staff of the Brick Industry Association. The information contained herein must be used in conjunction with good technical judgment and a basic understanding of the properties of brick masonry. Final decisions on the use of the information contained in this *Technical Notes* are not within the purview of the Brick Industry Association and must rest with the project architect, engineer and owner.

REFERENCES

1. *Brickwork Arch Detailing*, Ibstock Building Products, Butterworth & Co. (Publishers) Ltd., London, England, 1989, 114 pp.
2. Lynch, G., *Gauged Brickwork, A Technical Handbook*, Gower Publishing Company, Aldershot, Hants, England, 1990, 115 pp.
3. Trimble, B.E., and Borchelt, J.G., "Jack Arches in Masonry Construction," *The Construction Specifier*, Construction Specifications Institute, Alexandria, VA, January 1991, pp. 62-65.