

Brick Veneer/Concrete Masonry Walls

Abstract: This *Technical Note* presents design, material and construction information for anchored brick veneer on concrete masonry backing. Description of properties, theories of structural design and proper detailing are presented. Refer to *Technical Notes* 28 and 28B for specific information related to drained wall assemblies with non-masonry backing.

Key Words: anchored, brick, concrete masonry, design, expansion joints, flashing, thermal resistance, ties, veneer.

SUMMARY OF RECOMMENDATIONS:

Drainage/Air Space

- 2 in. (51 mm) minimum air space recommended; 1 in. (25.4 mm) minimum air space* required
- For brick veneer, do not exceed 6 $\frac{1}{8}$ in. (168 mm) between back of veneer and face of inner wythe unless ties are designed (see Ties)
- For non-composite multi-wythe walls, do not exceed 4 $\frac{1}{2}$ in. (114 mm) maximum between back of outer wythe and face of inner wythe
- Completely fill air space below wall base flashing with mortar or grout
- Where continuous insulation is placed in drainage cavity, provide no less than a nominal 1 in. (25.4 mm) clearance between the back of outer wythe and exterior face of insulation

* An air space is allowed to be a 1 in. (25.4 mm) nominal dimension in the *IRC* and a 1 in. (25.4 mm) specified dimension in the *IBC* to account for construction tolerances.

Flashing

- Install at base of wall, at shelf angles, above window heads, below window sills and at other locations where air space is interrupted
- Extend vertical leg of flashing a minimum of 8 in. (203 mm) and terminate in bed joint of inner wythe or with termination bar
- Where flashing laps are required, provide minimum 6 in. (152 mm) overlap and seal
- Where flashing is discontinuous, form end dams by turning ends up at least 1 in. (25.4 mm) into a head joint

Weeps

- Place immediately above flashing
- Open head joint weeps preferred. Spacing recommended to be no more than 24 in. (610 mm) o.c.

Ties

- Select ties and spacing appropriate for wall construction and the intended level of connection between the two wythes (non-composite or veneer)
- Use wall ties that distribute lateral loads and accommodate differential movement between wythes
- Use one of the following tie types: unit ties, joint reinforcement, adjustable unit ties, or joint reinforcement with adjustable ties
- Except as noted herein, do not use corrugated ties
- Space ties at a maximum of 32 in. (813 mm) horizontally and 25 in. (635 mm) vertically
- For an air space not exceeding 4 $\frac{5}{8}$ in. (117 mm), provide at least one tie with wire size W1.7 (MW11) per 2.67 sq ft (0.25 m²) of wall area; or at least one tie with wire size W2.8 (MW18) per 3.5 sq ft (0.33 m²) of wall area

- For an air space wider than 4 $\frac{5}{8}$ in. (177 mm) and not exceeding 6 $\frac{5}{8}$ in. (168 mm), provide at least one tie conforming to the requirements of [Table 1](#) per 2.67 sq ft (0.25 m²) of wall area
- For an air space exceeding 6 $\frac{5}{8}$ in. (168 mm), design ties using TMS Code "Alternative design of anchored masonry veneer" provisions
- Provide additional ties within 12 in. (305 mm) of openings larger than 16 in. (406 mm) at a maximum spacing of 3 ft (0.91 m) o.c.
- At columns or other interruptions, install special versions of ties intended for attachment to steel and concrete

Shelf Angles/Lintels

- Provide steel angles conforming to ASTM A36 with a minimum thickness of $\frac{1}{4}$ in. (6.4 mm)
- Size horizontal leg of shelf angles and lintels to provide minimum bearing of two-thirds the thickness of the brick wythe
- Install continuous flashing above shelf angles and lintels
- Use shelf angles to support veneer exceeding a height of 50 ft (15.24 m)
- Fasten shelf angles to structure using bolts with cast-in inserts, miscellaneous metal fabrications or post-installed anchors
- Where required, provide standoff shelf angle assemblies to allow installation of continuous insulation behind angle

Expansion Joints

- Provide vertical and horizontal expansion joints through brick veneer
- Design and construct expansion joints complying with recommendations of *Technical Note* 18A

Insulation

- Conduct hygrothermal analysis to determine the optimum type, location and amount of insulation
- Where required, install insulation in one or more of the following locations within the wall assembly: the air space/drainage cavity, the cells of hollow unit backing, or on the interior face of the interior wythe using studs or furring strips

Water Resistive Barriers, Air Barriers and Vapor Retarders

- Conduct hygrothermal analysis to determine suitability and location of air barriers and vapor retarders
- Install sheet, spray or fluid-applied air barrier membrane on exterior face of backing, or detail insulation joints to function as an air barrier
- Installation of sheet, spray or fluid-applied water-resistive barrier membrane preferred but not required

PROPERTIES OF BRICK VENEER/MASONRY WALLS

Resistance to Moisture Penetration

Brick veneer with CMU backing is more resistant to water penetration than barrier wall construction. If moisture penetrates the exterior wythe of masonry, the air space directs it down the back of the exterior brick wythe to the flashing at the bottom of the air space, where it is diverted to the exterior. For further discussion of moisture penetration resistance, refer to the *Technical Note 7 Series*.

Thermal Properties

Both the materials and the construction of the veneer wall assembly contribute to its thermal properties. Brick masonry exhibits significant thermal mass, the ability to store and slowly release heat. These properties help shift the peak heating or cooling loads to off-peak times and reduce the peak temperatures. Current energy codes accommodate thermal mass by requiring a lower R-value for mass walls. Refer to the *Technical Note 4 Series* for more information.

The separation of the exterior and interior wythes by the air space reduces clear field thermal bridging and reduces the rate at which heat moves through the wall assembly. Insulation may be placed in the air space by attaching or spraying continuous insulation on the backing, or it may be placed in the masonry cores of the backing by filling them with granular fill or foam. Insulation may also be placed on the interior face of the backing, where it is typically placed between furring strips supporting gypsum wallboard interior finishes.

Fire Resistance

Fire resistance ratings of brick veneer walls with CMU backing range from 2 to 4 hours, depending upon the wall thickness and other factors. The fire rating of various types of brick wall assemblies with CMU backing can be calculated using the formulas in *Technical Note 16*. The inclusion of plastic-based materials (such as drainage board, insulation and mortar dropping collection devices) within the air space may increase the risk of fire spread within the wall assembly. To evaluate this condition, the *IBC* requires NFPA 285 testing to be conducted on such wall assemblies to determine the potential for fire propagation. Certain brick and CMU wall assemblies that have a maximum clearance between the brick and the insulation of 1 in. (25.4 mm) qualify for an exception in the *IBC* and do not require NFPA 285 testing.

Sound Transmission

Sound on one side of a wall assembly can cause vibration of the closest masonry wythe. In a multi-wythe masonry wall, the air space provides a partial isolation of the two wythes, which creates a cushioning effect. This cushioning effect, combined with the mass of the masonry, dampens and greatly reduces the vibration caused by the sound source. For instance, a wall with a 4 in. (250 mm) thick brick veneer and a hollow 8 in. (203 mm) thick CMU backing has a Sound Transmission Class (STC) rating of 53, which is usually sufficient for substantially reducing transfer of typical interior and exterior noises. Similar values can be achieved for Outside-Inside Transmission Class (OITC) ratings. For more information on sound transmission, see *Technical Note 5A*.

INTRODUCTION

Drained multi-wythe brick masonry walls were first built in the United States as early as 1850. Their early use was limited primarily to exterior loadbearing walls one or two stories in height. In the 1940s, designers of high-rise buildings began to recognize the advantages of this wall system and used it as an exterior curtain wall element or an infill wall element on buildings with structural frames. Since then, the system has been adopted for both loadbearing and non-loadbearing applications and used extensively throughout the United States in a wide variety of building types. Today, drained multi-wythe brick masonry walls remain popular due to their versatility and the long-term successful performance of the wall assembly.

General Construction

Drained multi-wythe brick masonry walls consist of two wythes of masonry separated by an air space and mechanically connected with adjustable ties or horizontal joint reinforcement. As required, the drainage cavity

may also include continuous insulation and an air/moisture/vapor barrier. When a drained multi-wythe brick masonry wall encloses occupied space, furring members and gypsum wallboard are typically installed on the interior face of the interior wythe. Placement of insulation in the wall assembly may vary and can include insulation in the air space, insulation within the cells of hollow masonry units or insulation inboard of the interior wythe, as well as various combinations of these locations.

Various materials can be used in a multi-wythe masonry wall. The exterior wythe generally consists of solid or hollow brick but can also include architectural concrete masonry units (CMU), calcium silicate units or cast stone accents. The interior wythe can consist of large-scale hollow brick, structural clay tile or CMU. An example using a solid brick exterior wythe and a CMU interior wythe is depicted in [Figure 1](#).

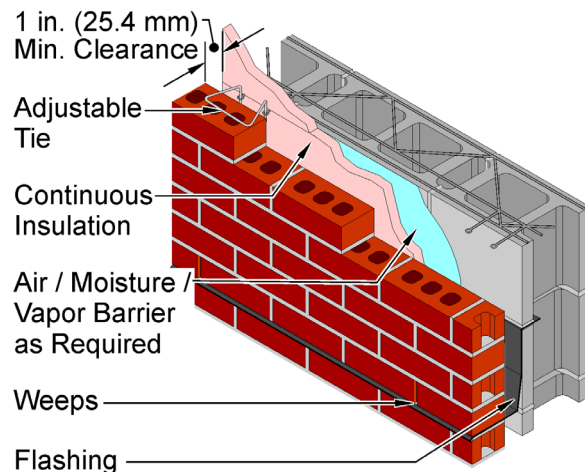

Figure 1
Typical Brick Veneer/CMU Wall

Structural Performance

The various configurations and uses of multi-wythe masonry demonstrate the versatility of this wall assembly. A multi-wythe masonry wall can be either loadbearing or non-loadbearing, and within those categories it can consist of composite, non-composite or veneer construction. These categories are described in more detail as follows:

Loadbearing vs. Non-Loadbearing. A loadbearing wall is defined by its role as a primary element in the structural system of the building. It carries both gravity load (dead load, live load) and lateral load (forces from wind and earthquake). A non-loadbearing wall is a secondary element in the structural system. It does not carry gravity load, other than its self-weight, but resists lateral load and transfers it to the structural frame of the building.

Composite, Non-Composite and Veneer. These terms describe how the wall assembly resists the loads applied to it. In a composite wall, both wythes work together as a single element, resisting both lateral and vertical loads. The ties must meet specific requirements for size and spacing in order to connect the two wythes such that composite behavior is achieved. A non-composite wall is similar; however, each wythe resists a proportion of the load individually based on its stiffness. The ties connecting the non-composite wythes permit loads to be transferred among wythes, but the ties are not sufficient to create shared load resistance by the combined section. In veneer walls, the exterior wythe (veneer) does not resist any load other than its self-weight and only transfers lateral load to the backing, which resists the full load.

Anchored Veneer vs. Cavity Wall. Nearly all multi-wythe masonry walls constructed today consist of an exterior wythe categorized as an anchored veneer. Another category of multi-wythe masonry is a cavity wall, which is less prevalent today. As defined by TMS 402, *Building Code Requirements for Masonry Structures* (TMS Code) [Ref. 2] and TMS 602, *Specification for Masonry Structures* (TMS Specification) [Ref. 10], a cavity wall is a non-composite masonry assembly with a continuous air space separating at least two wythes and with ties connecting each wythe. However, many design and construction professionals refer to any brick veneer drained wall assembly as a cavity wall. Be sure to clarify terminology to avoid confusion.

This *Technical Note* will focus primarily on anchored brick veneer with a backing of concrete masonry because it is the most common combination for contemporary drained multi-wythe wall assemblies. For simplicity, this type of wall will be referred to as brick veneer/CMU (BV/CMU).

Building Science Performance

Modern building construction has increased energy efficiency, in part by incorporating materials and methods that were not used historically. Materials such as plastic-based insulation, air barriers and vapor retarders are regularly installed within wall assemblies, but they have a wide range of properties with respect to permitting or impeding the movement of moisture and air, as well as resisting or propagating fire.

While these materials help to improve performance, they must be used correctly to avoid unintended consequences. Differences in temperature and humidity between the interior and exterior of a building mean that moisture from the air may condense within the wall assembly. The goal is to control where condensation will occur through proper material selection and placement, and to create a location within the wall assembly that can manage the moisture and direct it to the exterior. In the case of a brick veneer wall assembly, the ideal location is the drainage cavity/air space.

Hygrothermal analysis, which models the heat and moisture flow through a wall assembly, can be used to determine points in the wall where condensation may occur. This modeling can also compare similar wall assemblies with different component materials, component placement and insulation thicknesses to determine the configuration best suited to the local climate and the code requirements for the project.

Specific to brick veneer wall assemblies, widening the air space to increase the drying potential of the wall and including continuous insulation in the drainage cavity to supplement the insulating function of the air space are effective strategies to force condensation to occur within the “wet zone” of the wall assembly. For further discussion on causes and prevention of condensation within brick veneer wall assemblies, refer to *Technical Note 47*.

DESIGN OF BV/CMU WALLS

The following describes the various components of the BV/CMU wall system in more detail, with commentary about the appropriate materials and their function.

Brick

Solid brick units must meet the requirements of ASTM C216, *Standard Specification for Facing Brick*, or ASTM C62, *Standard Specification for Building Brick* [Ref. 1]. Hollow brick units must meet the requirements of ASTM C652, *Standard Specification for Hollow Brick*. Grade SW brick is the default for brick conforming to ASTM C216, C62 and C652 and is recommended for use in most areas of the United States. Note that brick meeting ASTM C62 are not subject to appearance requirements. Grade MW brick can be used for interior wythes in these areas, but the limited availability and potential for construction errors may outweigh the benefit of its use.

Single-fired ceramic glazed brick used for either the exterior or interior wythe of BV/CMU walls must meet the requirements of ASTM C1405, *Standard Specification for Glazed Brick (Single Fired, Brick Units)*. Other ceramic glazed units may conform to ASTM C126, *Standard Specification for Ceramic Glazed Clay Facing Tile, Facing Brick and Solid Masonry Units*, or other appropriate standards.

Information on the classification and selection of brick can be found in *Technical Notes 9A and 9B*, respectively. Further information on brick masonry material selection for adequate strength and compliance with the TMS Code and Specification can be found in the *Technical Note 3 Series*.

Other Masonry Units

CMU. As indicated in the “General Construction” section of this *Technical Note*, CMU are usually installed as the backing material for exterior brick veneer. CMU with an architectural finish may also be used as accent bands in the exterior brick wythe. Solid and hollow concrete masonry units must conform to ASTM C90, *Standard Specification for Loadbearing Concrete Masonry Units*, or ASTM C1634, *Standard Specification for Concrete Facing Brick*, respectively.

Structural Clay Tile. Structural clay tile may also be used as the interior wythe of multi-wythe masonry wall construction. Structural clay tile used for this purpose must conform to ASTM C34, *Standard Specification for Structural Clay Loadbearing Wall Tile*, or ASTM C212, *Standard Specification for Structural Clay Facing Tile*. Where structural clay tile are glazed, they must also conform to ASTM C126, *Standard Specification for Ceramic Glazed Structural Clay Facing Tile, Facing Brick, and Solid Masonry Units*. Clay tile conforming to ASTM C212 and C126 are sometimes used for the interior wythe of a multi-wythe masonry wall when left exposed for their architectural appearance.

Cast Stone. Cast stone is a specialty architectural concrete product fabricated to replicate natural cut building stone, such as limestone. As such, cast stone units are frequently used within brick facades as sills, fenestration surrounds, keystones, copings, water tables, and other trim or accent elements. Cast stone must conform to

ASTM C1364, *Standard Specification for Architectural Cast Stone*, and the *Standards for Architectural Cast Stone* (TMS 404, 504 and 604) [Ref. 12], which cover the design, fabrication and installation of cast stone.

Calcium Silicate Units. Calcium silicate masonry is a non-cementitious manufactured stone product that is formed using pressure and cured in an autoclave. It is used similarly to cast stone as an accent element in an exterior brick facade. Calcium silicate units must conform to ASTM C73, *Standard Specification for Calcium Silicate Brick (Sand-Lime Brick)*.

Mortar

Masonry mortar must conform to the requirements of ASTM C270, *Standard Specification for Mortar for Unit Masonry*. This standard includes a proportion-based specification and a property-based specification for each mortar Type; the proportion-based option is the default and is most commonly specified. Type N or S mortars are typically used in brick masonry veneer walls, with Type N preferred in veneer or non-loadbearing applications and Type S preferred in loadbearing applications. Mortars with air content of less than 12 percent are recommended for their bond strength and resistance to moisture penetration.

Portland cement-lime, mortar cement or masonry cement mortars can be used. While all three mortar Types meet specifications, they are not equal and must be evaluated for project-specific compatibility. The TMS Code requires reduced allowable flexural tensile stresses for assemblies constructed with masonry cement mortars or air-entrained portland cement-lime mortars. In addition, the TMS Code prohibits the use of all Type N mortars in Seismic Performance Categories D and E and permits the use of masonry cement mortars only if the masonry elements are fully grouted.

See the *Technical Note 8 Series* for more detailed information on mortar Types and selection, and *Technical Note 7A* for a discussion of brick and mortar compatibility.

Drainage Cavity/Air Space

The drainage cavity or air space between wythes is permitted to vary from 1 to 6 $\frac{5}{8}$ in. (25.4 to 168 mm), per the prescriptive requirements of the TMS Code. Although permitted, air spaces less than 2 in. (50 mm) are not recommended. Where the exterior wythe acts as a veneer, the prescriptive requirements of the TMS Code permit the air space to be a maximum of 6 $\frac{5}{8}$ in. (168 mm) wide. Where the exterior wythe acts as a part of a non-composite wall, the prescriptive requirements are for an air space no wider than 4 $\frac{1}{2}$ in. (114 mm).

In many climate zones, the optimum location to place continuous insulation in the wall assembly is the air space. When insulation is placed in the air space, the clearance from the interior of the brick to the exterior side of the insulation must be no less than a nominal 1 in. (25.4 mm). This provides sufficient space for the mason to lay the brick properly and for the wall to function as a drainage wall.

For air spaces between 4 $\frac{5}{8}$ and 6 $\frac{5}{8}$ in. (117 and 168 mm), more substantially sized ties are required. Air spaces greater than 6 $\frac{5}{8}$ in. (168 mm) may adversely impact the ability of typical masonry ties applied at the code-prescribed spacing to properly transfer lateral loads. Where these larger air spaces are used, supplemental and/or stronger ties are generally necessary to achieve adequate load transfer capability, which requires additional product research and engineering analysis.

Insulation

Properties of insulation materials vary widely. Due to the large number of types of insulation, and the even larger number of manufacturers, individual manufacturers must be consulted for design values and other properties of their specific materials and their applications. Manufacturers' literature should be reviewed in detail before selection. In general, plastic insulation placed within a wall assembly requires testing to determine its potential to contribute to fire spread per NFPA 285 [Ref. 8]. However, the *International Building Code (IBC)* [Ref. 5] does not require this testing when the plastic insulation is covered on each face by 1 in. (25.4 mm) or more of masonry or concrete, the air space is limited to 1 in. (25.4 mm), and the plastic insulation has a Class A flame spread rating. If needed, many manufacturers of insulation installed in masonry wall assemblies have results for NFPA 285 available for review.

Refer to the *Technical Note 4 Series* for more information on energy and insulation of brick masonry walls and to *Technical Note 47* for information on prevention and control of condensation.

Placement. There are multiple options for insulation placement within a BV/CMU assembly. Insulation can be placed 1) in the drainage cavity/air space; 2) in the cells of hollow unit backing; or 3) on the interior face of the interior wythe between studs or furring strips. The optimum location and amount of insulation needed for a particular building can be obtained from hygrothermal analysis. In recent years, the thickness of insulation required within the drainage cavity has increased in many climate zones. The use of standoff shelf angles permits insulation installed in the drainage cavity to continue behind the vertical leg of the angle, which reduces the thermal bridging effect caused by the shelf angle. When insulation is installed in the drainage cavity/air space, it is critical that the product be intended for use in the “wet zone” of a wall assembly and have an established history of successful use in this application. Insulation applied to the drainage cavity side of the interior wythe can sometimes form part of the air barrier system. For insulation to work effectively as an air barrier, proper attachment to the interior masonry wythe and fully sealed or taped joints are necessary.

Board Insulation. Many board insulation materials can be installed in the air space of BV/CMU walls. Among the most common are rigid plastic foams: expanded polystyrene (EPS), extruded polystyrene (XPS) and polyisocyanurate. Mineral wool is considered semi-rigid and is included within this category, as it is typically installed in similar-sized sheets and locations as rigid board insulation. Although similar in appearance to fiberglass batt insulation, mineral wool is fire-resistant and does not absorb moisture, resisting rot and biological growth while maintaining its R-value. Insulation boards are attached to the interior face of the drainage cavity using insulation adhesive or mechanical fasteners, which can include clips or plates that slip over the veneer ties. A minimum clearance of a nominal 1 in. (25.4 mm) must be maintained between the face of the insulation and the back of the brick.

Rigid board insulation must conform to one of the following material standards: ASTM C578, *Standard Specification for Rigid, Cellular Polystyrene Thermal Insulation*; ASTM C1224, *Standard Specification for Reflective Insulation for Building Applications*; or ASTM C1289, *Standard Specification for Faced Rigid Cellular Polyisocyanurate Thermal Insulation Board*. Mineral wool insulation for use in BV/CMU walls must conform to ASTM C612, *Standard Specification for Mineral Fiber Block and Board Thermal Insulation*.

There are also proprietary formed rigid foam inserts that can be used as integral insulation placed inside the cells of hollow CMU to improve thermal and sound transmission performance. These products are generally made from EPS foam.

Granular Fills. Granular fills are typically used in the hollow cells of concrete block backing. One advantage of granular fills is that they can be installed after wall sections have been completed. This permits the mason to work uninterrupted, shortening construction time and lowering costs. However, the water resistance of the fill is of utmost importance. Settling of the fill material may lead to thermal bridging in the wall system. Two types of granular fill may be used for BV/CMU insulation: water-repellent vermiculite and silicone-treated perlite insulation. EPS bead granular fill is not recommended.

Vermiculite is an inert, lightweight material manufactured by expanding an aluminum magnesium silicate mineral, which is a form of mica, to 15 times its original size by subjecting it to high temperatures. Perlite is a white, inert, lightweight material made from crushed volcanic siliceous rock. Exposure to high temperature creates a void structure within the rock, and further heating can expand perlite to 20 times its original volume. Water-repellent vermiculite and silicone-treated perlite must conform to ASTM C516, *Standard Specification for Vermiculite Loose Fill Thermal Insulation*, and ASTM C549, *Standard Specification for Perlite Loose Fill Insulation*, respectively. Each of these specifications contains limits on density, grading, thermal conductivity and water repellency.

Installation of granular fill is relatively straightforward. Bags of material are placed into the top of the open cells, either directly or via hoppers. A 20 ft height limit for a placement lift is recommended to ensure that the cells are fully filled without gaps. To maintain the thermal performance, do not rod or tamp the fill.

Foamed-in-Place. Foamed-in-place insulation has traditionally been used to fill the cells of hollow masonry units. These foams may consist of cementitious material (magnesium oxychloride cement and ceramic talc) or aminoplast resin. One advantage of foamed-in-place insulation is that it can be installed after wall sections have been completed, which is beneficial for filling cells of hollow masonry. The insulation is placed under pressure through ports in the side of the wall. Newly constructed walls must be allowed to cure long enough to resist the pressures applied. Foamed-in-place insulation does not have an ASTM material standard, but the performance properties of the material are determined using relevant ASTM test standards.

Spray Polyurethane Foam. Spray foam insulation can be applied directly to the outer face of the interior wythe of a BV/CMU wall and can serve as a water-resistive barrier and an air barrier. When used in the drainage cavity or on the interior face of a wall, spray foam insulation is typically applied before the exterior brick wythe or interior finishes are installed. Polyurethane spray foam must comply with ASTM C1029, *Standard Specification for Spray Applied Rigid Cellular Polyurethane Thermal Insulation*.

One disadvantage of spray foam is that shrinkage of the foam may occur. This condition could lead to moisture drainage paths and air leakage through the wall system; therefore, compatible membranes are installed at edges and transitions on the interior wythe to ensure coverage of the underlying substrate when shrinkage occurs.

Most foams are multicomponent systems formed by a chemical reaction of two or more liquids that expand when combined and require specialized equipment to install. The insulation materials that fall within the categories of foamed-in-place and spray foam have different properties and characteristics, such as open cell vs. closed cell, resistance to moisture and R-values. As such, some foams may be better suited to filling cells in hollow masonry than filling the drainage cavity/air space. Manufacturers' literature should be consulted for technical information on applications and usage.

Air Barriers, Water-Resistive Barriers and Vapor Permeance

As discussed in the previous section, insulation can be placed in the drainage cavity/air space, in the cells of hollow unit backing or on the interior face of the interior masonry wythe. The placement of the insulation plays a role in determining where the air barrier and vapor retarder should be installed within the wall assembly. The results of the hygrothermal analysis can help determine the placement of the air barrier and vapor retarder.

Air Barriers. Controlling airflow within the wall assembly helps to eliminate drafts and prevents moisture-laden air from reaching areas of the wall assembly intended to remain dry. As a result, building codes require air barriers. Per the *International Energy Conservation Code (IECC)* [Ref. 6], an air barrier consists of "one or more materials joined together in a continuous manner to restrict or prevent the passage of air through the building envelope and its assemblies." Masonry walls with CMU backing can appear relatively airtight but may experience air leakage when a dedicated air barrier product is not used. The use of block filler or two layers of paint allow a CMU wall to comply as an approved air barrier assembly. Some air barrier materials such as membranes or insulation can also perform as water-resistive barriers.

Water-Resistive Barriers. Water-resistive barriers (WRB) are intended to resist liquid water that has penetrated behind the exterior wythe from further intruding into the wall assembly. The use of a WRB is not required by building codes for wall assemblies with masonry or concrete backup construction, but a WRB is sometimes installed on the exterior face of the interior wythe to protect against ingress of incidental moisture or moisture-laden air that reaches that interface. If applied, the WRB must be continuous over the backing and must be sealed at interfaces with other elements or materials.

Parging. Historically, parging the exterior or interior face of the interior masonry wythe with mortar was used to reduce air and water leakage. However, the effectiveness of parging is limited due to the tendency of cementitious materials to crack and because it is not recognized by the building code to serve as a water-resistive barrier. Parging qualifies as an air barrier assembly per the *IECC*, provided that it is portland cement based and has a minimum ½ in. (13 mm) thickness. In some cases, parging may be recommended for application as a substrate for another air barrier or water-resistive barrier membrane; however, the manufacturers of air barrier and water-resistive barrier membranes typically have their own surface preparation requirements that may or may not be compatible with the use of parging.

Vapor Permeance. A material's vapor permeance controls the amount of moisture that can be transmitted through it (vapor diffusion). Materials with a higher vapor permeance/permeability are often referred to as "breathable." Both air barriers and water-resistive barriers can have various levels of permeability; the suitability of a particular product depends on the code requirements for a vapor retarder in the wall assembly and the results of the hygrothermal analysis.

In-depth discussion of air barriers, water-resistive barriers and vapor retarders is outside the scope of this *Technical Note*. There are many building science resources available for reference [see Ref. 3]. For buildings with unusual walls, consultation with building envelope professionals is recommended for development of project-specific recommendations for materials and placement of those materials in the wall assembly. For further discussion on air barriers, water-resistive barriers and vapor retarders, refer to the *Technical Note 7 Series*.

Wall Ties/Anchors

For the purposes of this *Technical Note*, the term “tie” is used to describe a fastener connecting the veneer to the backing or an outer wythe to an inner wythe. The TMS Code uses the term “anchors” to describe the fasteners that attach the brick veneer to the structural backing. In the context of composite or non-composite walls, the term “anchors” sometimes refers to fasteners used to connect the inner wythe of the wall to the structure, and the term “ties” refers to the fasteners used to connect the separate wythes of masonry.

For a tie system to function properly, it must meet the following criteria:

- Be securely attached to or embedded in the masonry wythes
- Have sufficient strength to transfer lateral loads with minimal deformations
- Have a minimal amount of mechanical play (if adjustable)
- Have sufficient corrosion resistance
- Be easily installed without damage to the tie system or other wall components

Connection to Frame. Masonry walls used to enclose or infill frame structures must be carefully designed and detailed to permit the transfer of loads applied to the wythes to the frame in a manner that accommodates differential movement. The anchorage of the exterior veneer to the building frame generally provides out-of-plane support for the veneer and resists tension and compression from the loads perpendicular to the plane of the wall. This permits in-plane differential movement between the building frame and the exterior veneer without causing distress. Ties must be designed and detailed to accommodate construction tolerance differences and differential movement resulting from loads applied to the frame and floor elements. Horizontal joint reinforcement and separate ties should not be placed in the same bed joint, as there is not adequate space to accommodate both and surround them with mortar.

Connection of Wythes. Ties serve three important functions: to provide a connection for each wythe, to transfer lateral loads between wythes and to accommodate differential movement between wythes. There are multiple tie types for use in brick veneer walls with CMU backing, including unit ties, horizontal joint reinforcement and adjustable ties. All types must conform to the applicable requirements for wire size, tie spacing and configuration listed in the TMS Code and summarized in [Table 1](#) and [Table 2](#).

TABLE 1
Adjustable Tie Requirements for Brick Veneer with a Backing of CMU or Concrete¹

Air Space, in. (mm)	Tie Type	Minimum Wire Size	Maximum Wall Area per Tie, sq ft (m ²)	Backing Attachment Requirements	Pintle or Adjustable Part Requirements
≤4 ⁵ / ₈ (117)	Joint Reinforcement with Adjustable Ties or Adjustable Unit Ties ²	W1.7 (MW11)	2.67 (0.25)	Ladder, Tab or Eye: Min. wire W1.7 (MW11) Plate: Min. 0.06 in. (1.5 mm) thick and 7/8 in. (22.2 mm) wide	Wire: Min. W2.8 (MW18) Pintle Legs: 1 min. Offset: Max. 1¼ in. (31.8 mm)
>4 ⁵ / ₈ (117) and ≤6 ⁵ / ₈ (168)	Joint Reinforcement with Adjustable Ties or Adjustable Unit Ties ²	W2.8 (MW18)	2.67 (0.25)	Ladder, Tab or Two Eyes: Min. wire W2.8 (MW18) Barrel: Min. ¼ in. (6.4 mm) outside dia. Plate/Prong: Min. 0.074 in. (1.88 mm) thick and 1¼ in. (31.8 mm) wide	Wire: Min. W2.8 (MW18) Pintle Legs: 2 min. Offset: Max. 1¼ in. (31.8 mm) Distance from Inside Face of Brick to End of Adj. Part: Max. 2 in. (51 mm)
>6 ⁵ / ₈ (168)	Design ties using TMS Code “Alternative design of anchored masonry veneer” provisions				

1. Tie requirements shown are for brick veneer with a backing of CMU or concrete, as appropriate. For multi-wythe masonry with composite or non-composite action, see the TMS Code for tie requirements.
2. Adjustable unit ties may also include a sheet-metal adjustable part (dovetail anchors). Sheet-metal adjustable parts should conform to backing attachment requirements for plate in air spaces less than or equal to 4⁵/₈ in.

TABLE 2

Non-Adjustable Tie Requirements for Brick Veneer with a Backing of CMU or Concrete¹

Air Space, in. (mm)	Tie Type ²	Minimum Wire or Plate Size	Maximum Wall Area per Tie, sq ft (m ²)
≤4 ⁵ / ₈ (117)	Joint Reinforcement and Unit Ties—Wire	W1.7 (MW11)	2.67 (0.25)
		W2.8 (MW18)	3.50 (0.33)
	Unit Ties—Sheet-Metal	Min. 0.06 in. (1.5 mm) thick and 7/8 in. (22.2 mm) wide	3.50 (0.33)
>4 ⁵ / ₈ (117) and ≤6 ⁵ / ₈ (168)	Joint Reinforcement	W2.8 (MW18) (longitudinal and cross wires)	1.77 (0.16) ³
>6 ⁵ / ₈ (168)	Design ties using TMS Code “Alternative design of anchored masonry veneer” provisions		

1. Tie requirements shown are for brick veneer with a backing of CMU or concrete, as appropriate. For multi-wythe masonry with composite or non-composite action, see the TMS Code for tie requirements.
2. It is recommended that unit ties in air spaces greater than 4⁵/₈ in. should be designed using TMS Code “Alternative design of anchored masonry veneer” provisions.
3. Recommended maximum wall area per tie. Assumes placement of joint reinforcement at 16 in. o.c. vertically (two courses of typical CMU).

Note that as the air space dimension increases, the requirements for ties become more stringent. Additional ties must be provided within 12 in. (305 mm) of openings larger than 16 in. (406 mm) at a maximum spacing of 3 ft (0.91 m) o.c. It is recommended to place ties within 12 in. (305 mm) of veneer expansion joints and edges of veneer.

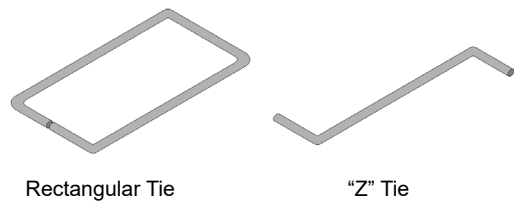
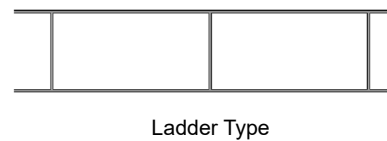
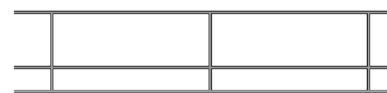

Figure 2
Unit Ties

Unit Ties/Anchors. Unit ties can be formed from wire or sheet-metal. Typical wire ties are rectangular ties or “Z” ties, as shown in Figure 2. Metal “Z” ties are intended to be used between wythes of solid masonry units only and are not appropriate for hollow masonry units. Rectangular ties can be used between the wythes of all masonry units, including solid and hollow units, and are therefore recommended for multi-wythe, non-composite masonry walls. Wire ties should be of wire size W1.7 (0.148 in. [3.8 mm]) or W2.8 (3/16 in. [4.8 mm]) in diameter. Sheet-metal ties must have a minimum base metal thickness of 0.06 in. (1.5 mm) or 16 gage.



Ladder Type



3-Wire Ladder Type



Truss Type



3-Wire Truss Type



Tab Type

Figure 3
Joint Reinforcement

Joint Reinforcement. Horizontal joint reinforcement configurations available are the ladder, truss and tab types shown in Figure 3. When used to tie the inner and outer wythes together, the interior and exterior wythes each receive at least one longitudinal wire. The longitudinal wires are connected by cross wires to tie the wythes together. Horizontal joint reinforcement is typically produced in 10 to 12 ft (3 to 4 m) lengths. Longitudinal wires are typically wire size W1.7 or W2.8 in diameter. Cross wires are also W1.7 or W2.8 in diameter and should be spaced at a maximum of 16 in. (406 mm) o.c. horizontally. The total thickness of the wires must not exceed one-half the mortar joint thickness.

Tests indicate that BV/CMU walls tied with horizontal joint reinforcement have similar performance to those

tyed with metal unit ties. These tests also indicate that truss type joint reinforcement used in BV/CMU wall construction helps to develop a degree of composite action in the horizontal span but does not contribute to any composite action in the vertical span. This restraint in the horizontal direction will reduce the amount of in-plane movement and could possibly result in bowing of the masonry walls. In addition, if the inner wythe consists of reinforced masonry, the diagonal cross wires of truss type joint reinforcement can conflict with the vertical reinforcing bars and the placement of grout in those cells. Therefore, truss type joint reinforcement is not recommended for BV/CMU walls. Instead, ladder type and tab type joint reinforcement, which allow for the in-plane movement between the wythes, are recommended.

Adjustable Unit Ties/Anchors. Adjustable unit ties typically consist of two pieces in a double eye and pintle configuration, shown in Figure 4. The piece with the eyes is installed during construction of the inner wythe, while the piece with the pintle(s) is installed during construction of the exterior wythe. Adjustable pintle ties are required to have a minimum wire size of W2.8 in diameter and a maximum vertical offset between the eye and pintle components of 1¼ in. (31.8 mm). In addition, adjustable ties should be detailed to prevent disengagement and have a maximum horizontal out-of-plane mechanical play within the connecting pieces of ¼ in. (1.6 mm).

Joint Reinforcement with Adjustable Ties/Anchors. Joint reinforcement with adjustable ties in a ladder and truss type configuration are also available, as shown in Figure 5. This type of tie consists of rectangular tie extensions with eyes connected to standard joint reinforcement. The use of the combined joint reinforcement and adjustable ties is preferred for brick veneer walls with CMU backing, as it avoids potential conflicts between unit tie wires and joint reinforcing wires.

Masonry Headers. Contemporary multi-wythe masonry walls are typically bonded by the use of metal ties; however, masonry headers may be encountered in older wall construction. A header is a masonry unit laid perpendicular to the exterior wythe, or sometimes at an angle to the exterior wythe, that is used to connect two wythes of masonry. The TMS Code still permits the use of masonry headers and includes provisions for the evaluation of their shear capacity, embedment and minimum percentage within the wall. Although the TMS Code allows wythes of masonry designed for composite action to be bonded structurally by masonry headers, they are not commonly used in contemporary construction. The use of masonry headers is no longer recommended due to their lack of ductility, limited ability to accommodate differential movement, and because they provide a direct path for water penetration from the outside of the wall to the interior along the head and bed joints.

Workmanship. Construction workmanship is critical to achieving high-performing masonry. While design, detailing and material selection is important, good workmanship cannot be overemphasized. Therefore, all mortar joints in both the exterior and interior masonry wythe should be completely filled as the brick—and CMU, if applicable—are laid. Face shell bedding of CMU is permitted. All mortar joints must be tooled or struck in a profile to consolidate the mortar at the surface of the brick masonry, which protects against water penetration. *Technical Note 7B* discusses more information related to workmanship issues for brick masonry. One workmanship consideration specific to BV/CMU construction is that both wythes of masonry must be adequately and properly tied together. The main concern for the designer is assurance that all the ties are firmly embedded in and bonded to the mortar. To achieve this, the masonry wythes must be laid with completely filled bed joints, and the ties must be spaced properly with a minimum ⅝ in. (16 mm) of mortar cover from the exterior face of the brick and a minimum embedment of 1½ in. (38.1 mm). Extensive data indicates that wall ties have excellent tying capacity when they

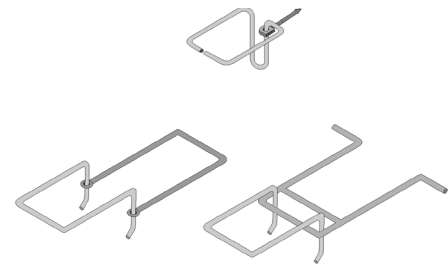

Figure 4
Adjustable Unit Ties

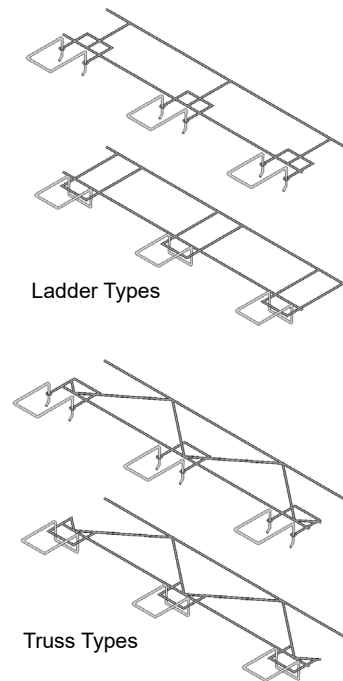

Figure 5
Joint Reinforcement with Adjustable Ties

are fully embedded in the masonry bed joints. If any ties are improperly embedded in the masonry units, the ties that are installed correctly will be required to carry the load of those that are not, resulting in potential overloading of ties and a weak structural system for the wall assembly as a whole.

Further discussion on proper tie selection and other applicable code requirements for veneer ties used with concrete or CMU backing is discussed in *Technical Note 44B*.

Shelf Angles/Lintels

Lintels provide support of brickwork over masonry openings by bearing on the brickwork on each side of the opening. They are not attached to the building structure. Shelf angles provide continuous intermediate support for the brickwork through connection to the building structure. Shelf angles are occasionally referred to as relieving angles.

Brick veneer walls with a rigid backing of concrete or CMU have no prescriptive height limitations in the TMS Code and therefore do not require the use of shelf angles. However, the maximum recommended height that brick veneer with this rigid backing may be supported at the foundation and between shelf angles is approximately 50 ft (15 m).

Shelf angles and lintels are designed similarly, except that a shelf angle must carry the full weight of brick masonry above, while a lintel is typically permitted to carry a reduced load due to the arching action of the wythe supported. Steel angles are most frequently used as shelf angles and lintels, but lintels may also be reinforced masonry, precast concrete or stone. Steel used for shelf angles and lintels must conform to the requirements in ASTM A36/A36M, *Standard Specification for Carbon Structural Steel*. All non-galvanized steel and non-stainless steel angles should be primed and painted (with a commercial or industrial corrosion-inhibiting coating) to prevent corrosion. In harsher climate conditions, consider the use of hot-dipped galvanized or stainless-steel angles.

Steel angles should have a minimum thickness of ¼ in. (6.4 mm). The horizontal leg of the shelf angle or lintel must be sized to accommodate a dimension of two-thirds the thickness of the brick veneer at a minimum. The maximum allowable deflection along the length of the shelf angle or lintel is L/600, and the total rotation of the toe of the shelf angle is limited to ¼ in. (1.6 mm). Lintels require a minimum bearing length of 4 in. (102 mm) on the brick at each side of the opening. Shelf angles should not be installed as one continuous member. Space should be provided at intervals to permit thermal expansion and contraction of the steel angle without causing cracking or other distress of the masonry.

For concrete structures, shelf angles are typically fastened using bolts corresponding to a matching wedge insert cast into the concrete. Alternatively, cast-in embed plates may be present on concrete structures, which permit welding as an attachment method. For steel structures, miscellaneous metal fabrications are used. Post-installed anchors designed for structural anchorage into cured concrete, grouted masonry and hollow masonry can also be used to connect shelf angles to the structure. The structural engineer for the project must design these fabrications and connections. Standoff shelf angles can be designed by the structural engineer, by fabricating miscellaneous metal brackets or by using prefabricated standoff shelf angle brackets. Prefabricated brackets may be either fully proprietary systems including brackets and the brick support or brackets intended for use with standard hot-rolled angle shapes. Where shims are installed between the shelf angle and the structure, the shims must extend the full height of the vertical leg of the angle to ensure that load transfer is consistent with the design.

For further information on the design of lintels and shelf angles, refer to *Technical Note 31B*.

Through-Wall Flashing

Through-wall flashing is an impervious material installed in a drainage wall system to contain and redirect moisture that has penetrated back to the exterior. Similar to other drainage wall assemblies, flashing is required at the base of the wall, above and below all wall openings, at shelf angles, at the tops of walls, beneath copings, and at any other discontinuities in the air space. Flashing should extend to the face of the exterior brick wythe at a minimum. However, extending the flashing beyond the face of the brick and forming a drip promotes improved drainage, which is preferred. Where flashing is not continuous, the ends of the flashing should be turned up a minimum of 1 in. (25 mm) to form an end dam.

Aspects of flashing unique to brick veneer with concrete or CMU backing include the following:

- The vertical leg of the flashing should extend up the backing a minimum of 8 in. (203 mm) and be terminated in a bed joint of the interior masonry wythe or a horizontal slot (reglet) in concrete. If

desired, flashing can be mounted to the face of the backing using a termination clamp or bar with fasteners intended for masonry or concrete applications.

- In some locations, the inner wythe of the BV/CMU wall is not continuous due to columns or other structural elements. The typical flashing details need to be modified to address these conditions; examples are detailed in *Technical Note 7*. Flexible flashings require support across any gaps. Installation of compressible fillers and sealants may be required between the inner masonry wythe and these structural elements to maintain watertightness above the flashing line.

For more information regarding proper flashing detailing, material selection and installation, refer to the *Technical Note 7 Series*.

Weeps and Drainage

Weeps direct moisture collected on the flashing to the exterior of the wall assembly. Weeps are required to be placed immediately above flashing at all locations. If weeps are installed one to two masonry courses above the flashing, they will not perform their intended function. The *IRC* and *TMS Code* require weeps to be placed no more than 33 in. (838 mm) o.c. An open head joint is the preferred type of weep. Open head joint weeps should be at least 2 in. (51 mm) high and are recommended to be spaced no more than 24 in. (610 mm) o.c. Metal or plastic screens or vents may be placed in the open head joint to discourage insect entry and to reduce the risk of weeps being closed during future maintenance work. Other types of weeps that can be used include rope wicks and weep tubes. See the *Technical Note 7 Series* for further discussion on weep types other than the open head joint.

Drainage Materials and Mortar Collection Devices. To the extent possible, the mason should prevent mortar droppings from falling into the air space. Excessive mortar droppings can render flashing and weeps ineffective in draining water to the exterior. Good workmanship during construction is the primary method of creating a functional air space. Mortar collection devices or full-height drainage media can be installed in the air space to help prevent obstruction by mortar. The use of these materials does not negate the importance of good workmanship. Manufacturers' literature should be used to determine the suitability of drainage materials. Use of drainage materials does not eliminate the risk for mortar bridging and may result in simply moving the mortar bridging higher within the air space. Therefore, many manufacturers require the flashing to be installed a minimum of 6 to 8 in. (152 to 203 mm) above the top level of the collection device to provide adequate protection against moisture ingress when mortar droppings accumulate. While it is important to keep the air space as free of mortar as possible, some mortar is permitted to be present per the building codes, provided that it does not impact the ability of the cavity to drain. For further discussion on weeps and mortar collection devices, refer to the *Technical Note 7 Series*.

Movement Joints

Brick masonry will expand and contract relative to other building components. These movements must be accommodated in the design and construction of the wall system in order to deter cracking, spalling and other potential brick masonry issues.

A system of veneer expansion joints, both horizontal and vertical, is used to accommodate differential movement and to reduce the potential for cracks. An expansion joint consists of an opening through the brick wythe that is closed with a sealant joint and compressible filler materials. These joints separate each section of brickwork and isolate it from other sections. The size, spacing, placement and compressibility of veneer expansion joints is critical to achieving the proper performance of the veneer. No single recommendation for the placement and spacing of veneer expansion joints can be applicable to all structures. Each exterior wall of the building must be evaluated to determine the extent of movement expected, based on the wall's length; the number, size and location of openings in it; its proximity to an offset, intersecting wall, or interior or exterior corner; any changes in height or support conditions; and whether it is exposed on both sides like a parapet. These features influence how the brick veneer reacts to movement in a wall. Any portion of a wall not able to resist the stress induced by the movement should be isolated by an expansion joint. For more information, refer to the *Technical Note 18 Series*.

Vertical Expansion Joints. Generally the spacing of vertical expansion joints should not exceed 25 ft (7.6 m) in walls without openings and 20 ft (6.1 m) in walls with multiple openings. Vertical expansion joints are also recommended where site walls adjoin buildings and at the corners of large openings. Building corners should have a vertical expansion joint located within 10 ft (3.05 m) of the corner. Plan offsets and setbacks of a wall

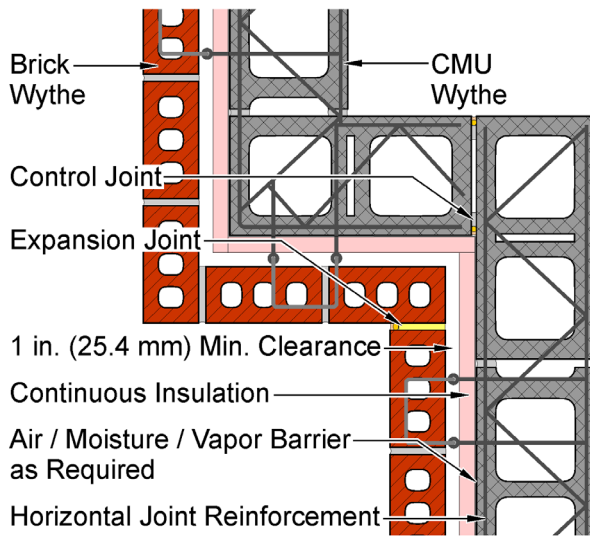

Figure 6
Vertical Expansion Joint at Interior Corner

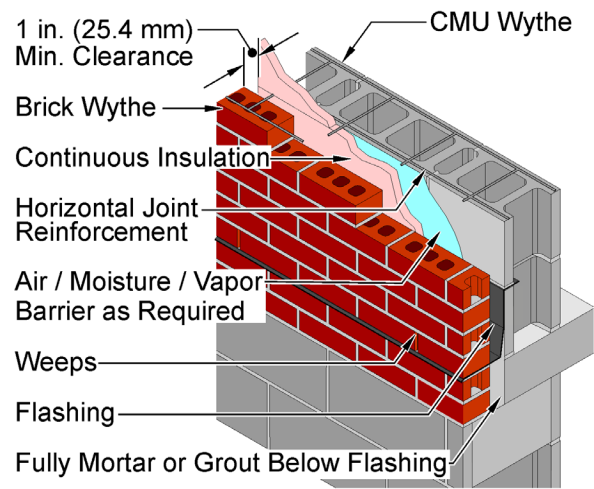

Figure 7
Basement Detail

should also include a vertical expansion joint on inside corners. Refer to [Figure 6](#) for a diagram of an expansion joint located at an interior corner.

Horizontal Expansion Joints. A horizontal expansion joint cannot function unless there is some means of supporting the brickwork above it. Usually this is accomplished by a shelf angle. These joints are located between the bottom of the shelf angle and the brickwork below. For further discussion of vertical and horizontal expansion joint details, refer to *Technical Note 18A*.

Control Joints. A brick veneer wall assembly with a concrete or CMU backing will include both control joints and veneer expansion joints. Control joints are installed in the concrete or CMU wythe to manage the shrinkage that results as the concrete or concrete masonry cures. Control joints are not required to align with the veneer expansion joints in the brick and may have separate spacing requirements.

SPECIAL CONDITIONS

Foundations

Foundations of brick, concrete masonry or concrete are used to support BV/CMU walls. The brick exterior wythe may be corbelled beyond the top of the foundation; however, the overhang may not be more than one-third of a brick unit width nor more than one-half of its height per course. The total distance corbelled may not exceed one-half of the brick unit width.

To prevent moisture penetration and to promote cavity drainage, the lowest level of flashing should be placed above the finished grade. With basement construction, it is important to use through-wall flashing at the bottom of the cavity to prevent moisture from penetrating through the basement wall; see [Figure 7](#). Below the flashing, any cavity should be filled solid with mortar or grout. Place flashing and weeps far enough above grade, up to 10 in. (254 mm) per the building code, so that they will not be covered by future grading or landscaping. Refer to the *Technical Note 7 Series* for more information regarding base-of-wall detailing.

A bond break is recommended between the exterior brick wythe and the foundation. This permits differential movement among the materials and reduces the likelihood of cracking. However, for non-composite walls, it must also be remembered that the flashing or bond break changes the structural boundary condition of the wall. The wythes separated from the foundation by flashing should be designed as simply supported or pinned end walls, not as a fixed end condition. If the exterior brick wythe is designed as a veneer, then this is not a concern.

Columns

When BV/CMU walls are used to enclose or infill a structural frame building, the inner wythe is generally aligned with the elements of the frame, such as columns. As such, when columns are encountered, units of the inner

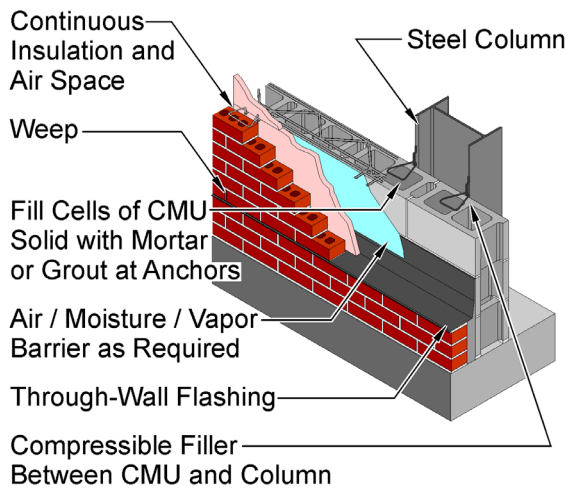

Figure 8
Anchorage to a Steel Column

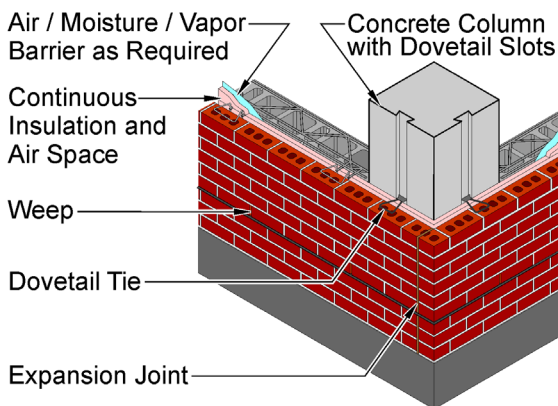

Figure 9
Anchorage to a Concrete Column

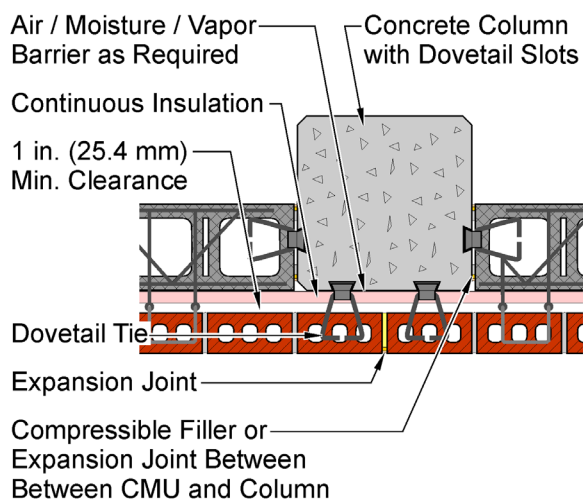

Figure 10
Anchorage to a Concrete Column at Expansion Joint

wythes are omitted to accommodate the column placement. Ties must not be omitted at column locations for either the inner or the outer wythes. Products are available that can be welded to steel columns, as well as ties that mechanically attach to the column flanges without welding, as shown in [Figure 8](#). At concrete columns, beams and walls, use of dovetail slots is recommended, per [Figure 9](#) and [Figure 10](#). These are metal channels that are placed prior to the concrete pour and provide the option to insert adjustable ties when the masonry is installed. Because the use of dovetail slots involves two different trades, careful coordination is required during the cast-in-place concrete submittal and shop drawing phase of the project to ensure that the slots are installed as intended. Special detailing for through-wall flashing may be required around columns. Refer to the *Technical Note 7 Series* for additional information.

Parapets

Of all the masonry elements used in buildings, the parapet wall is probably the most difficult to adequately detail. Designers have tried many ways to design parapets to minimize cracking, leaking and displacement. They are frequently required by building codes or for architectural or fire safety considerations.

The detail shown in [Figure 11](#) is suggested as one method of building a parapet. For BV/CMU wall construction, it is recommended that the cavity continue through the parapet, thereby maintaining the separation between the exterior wythe and the interior wythe. The interior masonry wythe of the parapet is reinforced and mechanically attached to the structural frame. It is recommended that designers consider the limitations of reinforced masonry construction as part of the parapet design. A typical 12 in. (305 mm) wide parapet with brick on both the exterior and interior faces will result in minimal cavity widths and a nominal 4 in. (102 mm) thick center wythe. The cells of nominal 4 in. (102 mm) CMU are generally too small to receive reinforcing bars and grout. An alternative to a reinforced masonry parapet is to use a concrete stem wall when the structure is concrete construction.

Copings on parapets must provide a drip on at least one side of the wall and slope toward the drip. Copings can consist of formed sheet-metal, stone or fired clay. Through-wall flashing should be placed in the mortar joint immediately beneath the coping, and the coping firmly attached to the wall below with mechanical anchors. Sealant compatible with the flashing must be applied where the anchors penetrate the flashing. Sheet-metal closures may be required to support the through-wall flashing membrane as it spans across the top of the cavity and beyond the face of the wall.

For sheet-metal copings, flexible membrane through-wall flashing should be installed directly below the metal. Note that temperatures under sheet-metal copings exceed those in a typical masonry assembly; therefore, the flashing membrane installed in this location must be formulated to withstand these higher temperatures. Sheet-metal copings are secured with cleats, thicker gauge metal fabrications that are attached to the vertical faces of the parapet.

In general, parapets should not be painted or coated; however, vapor-permeable “breathable” coatings can be permitted. Roofing membrane must not extend the full height of the parapet interior face without consideration of the impact on moisture vapor transmission. If the roof flashing terminates on the vertical surface of the parapet, then a layer of through-wall flashing is recommended to prevent moisture that saturates the interior face of the parapet from undermining the roofing termination, as shown in Figure 11.

Vertical expansion joints should extend through the parapet. Because a parapet receives environmental exposure on three sides, it is subject to increased expansion and contraction cycles compared with the main wall section and requires closer spacing of vertical expansion joints. Supplemental joints that occur only in the parapet can terminate at the first horizontal expansion below the base of the parapet. Ideally a shelf angle is present at the roof slab to serve as this termination point. Refer to the *Technical Note 18 Series* for more information regarding expansion joints.

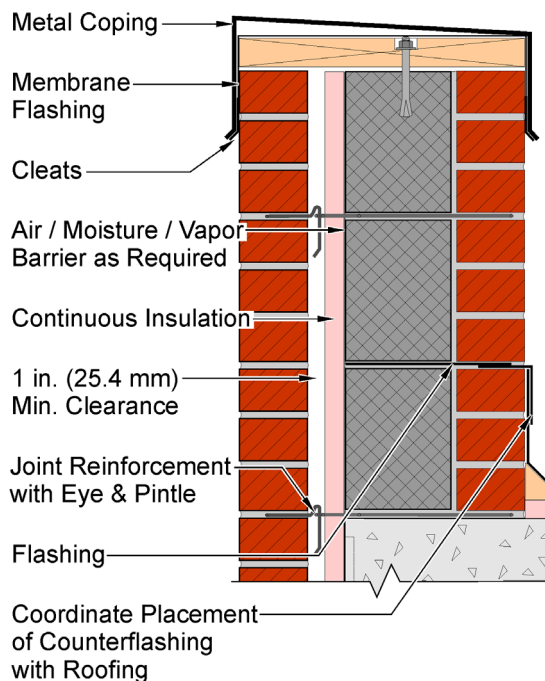

Figure 11
Metal Coping on Brick Veneer/CMU Wall Parapet

Doors and Windows

Detailing openings in BV/CMU walls requires special attention because any air or water that bridges the cavity may cause problems. A perimeter sealant joint at the exterior window/masonry interface is the primary defense against the ingress of both air and water.

Protection Against Air. Air barrier continuity must be maintained around window and door openings. If the air barrier is applied to the air space side of the interior wythe, membrane transition strips should wrap into the rough opening, and an interior air seal should be installed between the window frame or doorframe and the inner

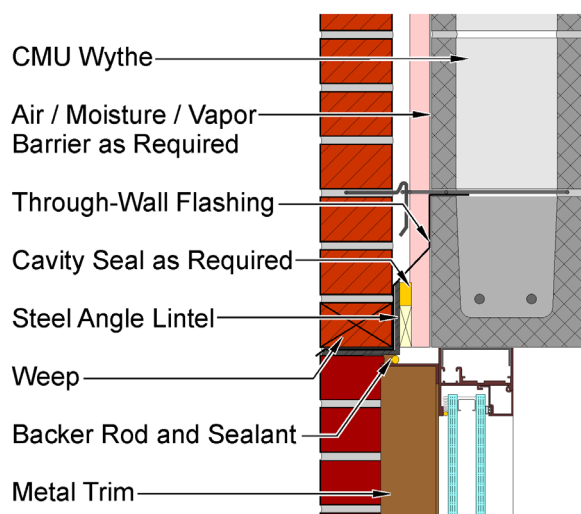

Figure 12
Window Head with Cavity Seal

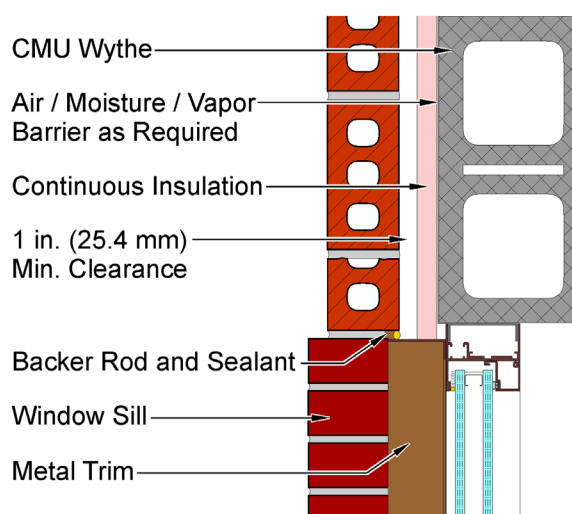

Figure 13
Window Jamb Detail

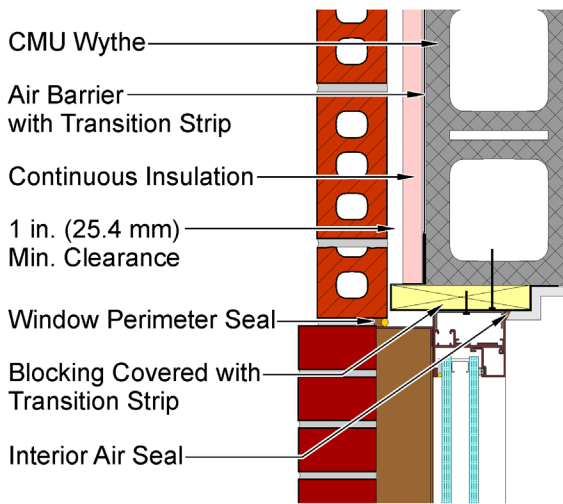

Figure 14

Window Jamb with Cavity Blocking Detail

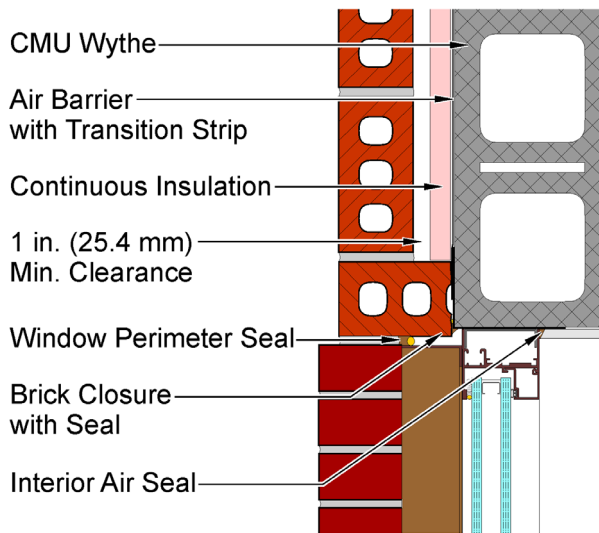

Figure 15

Window Jamb with Brick Closure Detail

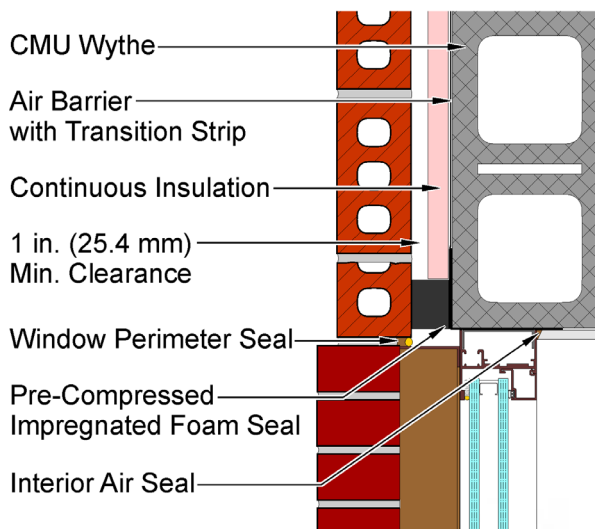

Figure 16

Window Jamb with Cavity Seal Detail

wythe. A second transition strip may be used as a cavity closure. Refer to the air barrier manufacturer's literature for recommended or preferred details. Placing mineral wool insulation, a pre-compressed joint filler or sealant in the cavity at the perimeter of the opening can also deter the air in the drainage cavity from reaching the window frame. Such a seal is typically placed at the head of the opening between the back of the lintel and the interior masonry wythe, per [Figure 12](#), and below the window sill. The seal must be integrated with a similar seal at the jamb between the two masonry wythes, per [Figure 13](#), [Figure 14](#), [Figure 15](#) and [Figure 16](#).

Protection Against Moisture. At window and door openings, flashing is required to keep cavity moisture from entering the window system and the interior, as well as to keep any moisture that bypasses the window system from entering the cavity. Window systems are designed only to weep moisture that penetrates the seals of the window frame and do not negate the need for flashing of the masonry opening itself. Similar to the treatment of all window openings in brick walls, through-wall flashing is installed at the head and below the window sill. When installed at these discrete locations, extend the flashing beyond the ends of the lintel or sill, and turn up to form end dams.

Flashing below the window sill is depicted in [Figure 17](#). Form end dams at the sides and the back of the sill flashing to form a pan beneath the window. Fully seal or solder, as applicable, seams and corners in the sill flashing. When one-piece continuous masonry sills with lugs are specified, the flashing should extend into the adjacent exterior masonry wythe at the jambs. When detailed in this manner, sill

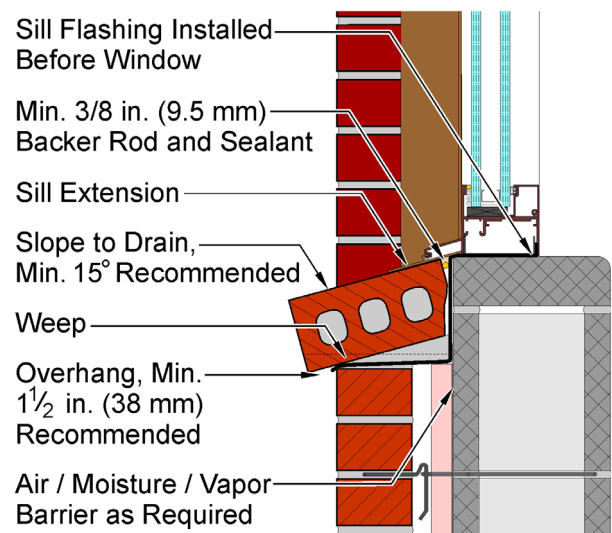

Figure 17

Window Sill Detail

flashing can manage water that bypasses the perimeter sealant joint at both the sill and jambs. Sealing the pre-compressed cavity seal at the jambs to the sill flashing completes a continuous barrier between the window frame and the cavity.

Jamb flashing is not required but may be placed between the interior masonry wythe and the window frame as an additional barrier. Jamb flashing should be fully adhered or sealed to the interior masonry wythe and extended down to lap over the through-wall flashing at the sill.

Structural Bearing

Cast-in-Place Concrete Slabs. Thermal strains or other movements are often blamed for cracking in masonry walls that is caused by the shrinkage or curling of concrete slabs that bear on the walls and are bonded to them. Curling of a concrete slab is generally caused by deflection of the slab when the forms are removed and in response to applied dead and live loads. Installation of a bond break between the concrete slab and the concrete masonry permits the slab to have some freedom of movement with respect to the plane of the wall. Thickening the slab into a beam over the interior wythe can help to stiffen the slab and minimize curling.

Open-Web Steel Joists. The coefficient of thermal expansion of steel is approximately twice that of brick masonry. When the temperature difference between the materials is large and the steel is firmly fastened to or confined within the masonry, the potential for cracking the masonry wall increases. Masonry bond beams are placed in the interior wythe below the steel joists to distribute the gravity load on the bearing wall. It is common practice to mechanically attach floor and roof joists to steel anchors embedded in the masonry, with slotted holes in the joist ends. Anchor bolts are installed snug-tight, not fully tensioned, in order to permit the necessary movement. The expansion and contraction capacity of this detail can be improved by lubricating the bearing surfaces or providing bearing pads with low coefficients of friction. The joist end should be separated from the grout in the bearing wall by surrounding the joist end with a layer of building paper prior to grouting in order to prevent unintended restraint. Minimum bearing requirements of the joists are established by the Steel Joist Institute and depend on the span and depth of the joist. **Figure 18** illustrates an example of a structural system using steel joists bearing on a masonry wall.

Precast Concrete Planks. Precast hollow-core concrete planks can bear on the interior wythe of a BV/CMU wall. In such cases, a minimum bearing of 3 in. (76 mm) is generally recommended, unless the structural engineer or manufacturer requires more stringent bearing depths. A bearing pad is recommended between the plank and the concrete masonry bond beam below. Mechanical anchorage to the wall may be achieved with reinforcing steel, similar to that shown in **Figure 19**. The structural engineer should design project-specific anchorage details.

Wood Framing. Wood floor joists constructed using beam pockets in the masonry normally have a 3 in. (76 mm) fire cut end and bear only on the interior wythe of a BV/CMU wall. The ends of the joists must not project into the drainage cavity. If they do, they can form a ledge, which may create a path for moisture ingress across the drainage cavity. Alternate framing support options include the use of standard metal joist hangers attached to a

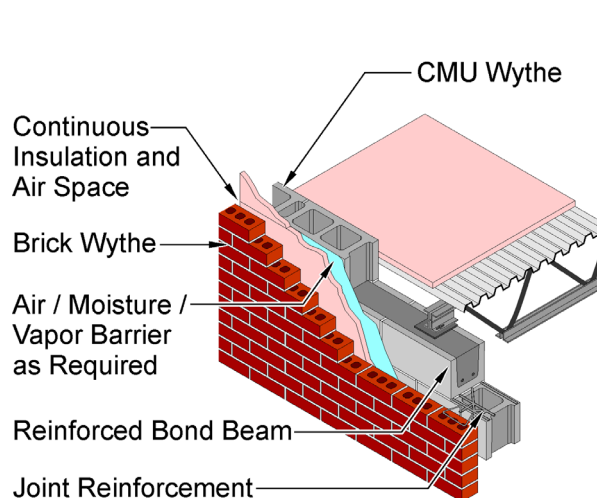

Figure 18
Steel Joist Bearing

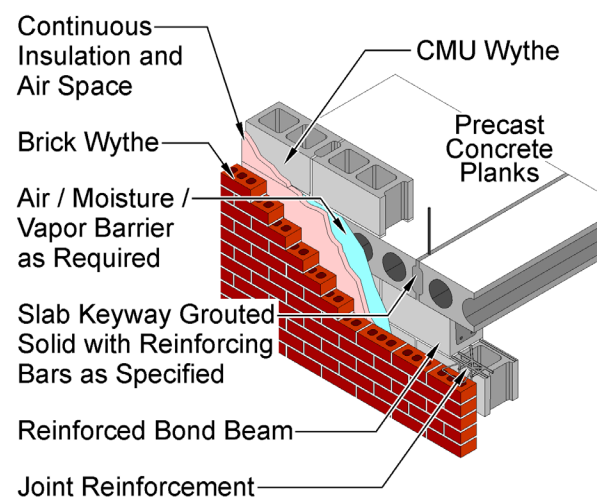

Figure 19
Steel Reinforced Concrete Plank Bearing

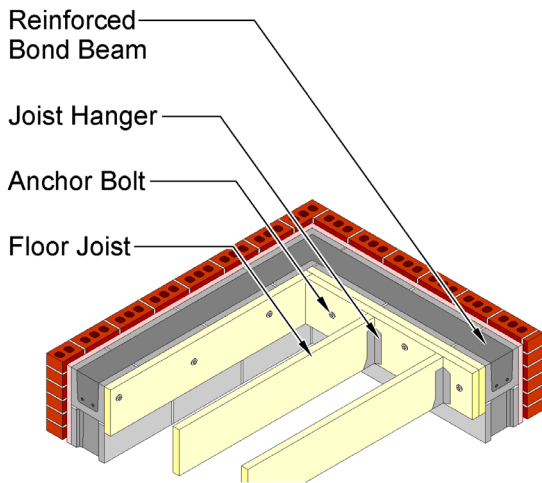

Figure 20
Wood Floor Joist Connection Detail

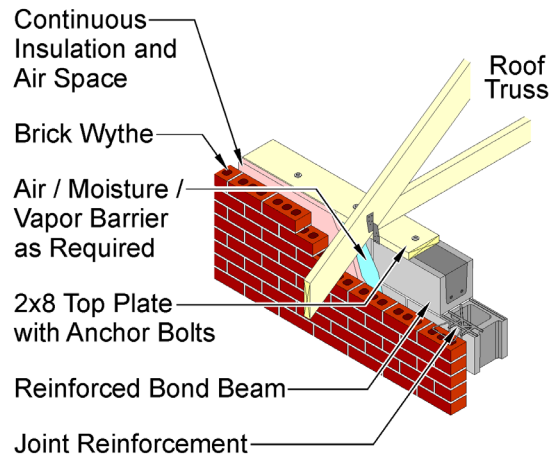

Figure 21
Wood Truss Bearing

ledger bolted to the inner wythe of CMU, per [Figure 20](#), or joist hangers intended for attachment to or integration into masonry may be connected to the inner wythe of the BV/CMU wall. Note that if the inner wythe consists of hollow masonry, then cells where anchors will be installed, such as those supporting the ledger board or individual hangers, must be grouted solid.

Wood roof framing can be anchored to BV/CMU walls by many methods; one of these is shown in [Figure 21](#). The detail illustrates a method in which the bearing plate is secured by anchor bolts grouted into the top of the cavity. The roof framing can then be attached to the bearing plate with strap anchors as shown. The actual required anchorage to the masonry must be determined by the structural engineer, but the TMS Code requires a minimum embedment of anchor bolts into masonry to be four bolt diameters or 2 in. (51 mm). Resistance to uplift forces on roof members may require longer bolt embedment or vertical reinforcement. After the wood plate is installed, the nuts must be hand-tightened, and the use of plate washers between the nuts and the wood plate is recommended.

Summary

This *Technical Note* provides an introduction to drained multi-wythe masonry walls, with a focus on the most common assembly of brick veneer with a backing of concrete masonry. The properties and general principles involved in the proper detailing and specification of brick veneer with concrete masonry backing are discussed. Proper selection and placement of flashing, weeps, ties, expansion joints, insulation, water-resistive barriers, air barriers and vapor retarders is provided. General information is also included on various structural bearing conditions that may be considered for a loadbearing concrete masonry interior wythe.

The information and suggestions contained in this Technical Note are based on the available data and the combined experience of engineering staff and members of the Brick Industry Association. This information must be used in conjunction with good technical judgment and a basic understanding of the properties of brick masonry. Final decisions on the use of the information contained in this Technical Note are not within the purview of the Brick Industry Association and must rest with the project architect of record, engineer of record and owner.

REFERENCES

1. *Annual Book of ASTM Standards*, ASTM International, West Conshohocken, PA, 2016:

Volume 1.04

A36/A36M Standard Specification for Carbon Structural Steel

Volume 4.05

C34 Standard Specification for Structural Clay Loadbearing Wall Tile

C62 Standard Specification for Building Brick (Solid Masonry Units Made From Clay or Shale)

C73	Standard Specification for Calcium Silicate Brick (Sand-Lime Brick)
C90	Standard Specification for Loadbearing Concrete Masonry Units
C126	Standard Specification for Ceramic Glazed Structural Clay Facing Tile, Facing Brick, and Solid Masonry Units
C212	Standard Specification for Structural Clay Tile Facing Tile
C216	Standard Specification for Facing Brick (Solid Masonry Units Made from Clay or Shale)
C270	Standard Specification for Mortar for Unit Masonry
C476	Standard Specification for Grout for Masonry
C652	Standard Specification for Hollow Brick (Hollow Masonry Units Made From Clay or Shale)
C1364	Standard Specification for Architectural Cast Stone
C1405	Standard Specification for Glazed Brick (Single Fired, Brick Units)
C1634	Standard Specification for Concrete Facing Brick

Volume 4.06

C516	Standard Specification for Vermiculite Loose Fill Thermal Insulation
C549	Standard Specification for Perlite Loose Fill Insulation
C578	Standard Specification for Rigid, Cellular Polystyrene Thermal Insulation
C612	Standard Specification for Mineral Fiber Block and Board Thermal Insulation
C1029	Standard Specification for Spray-Applied Rigid Cellular Polyurethane Thermal Insulation
C1224	Standard Specification for Reflective Insulation for Building Applications
C1289	Standard Specification for Faced Rigid Cellular Polyisocyanurate Thermal Insulation Board

2. *Building Code Requirements for Masonry Structures* (TMS 402-16), The Masonry Society, Longmont, CO, 2016.
3. Building Science Corporation, Westford, MA:
 - Building Science Digest 012: Moisture Control for New Residential Buildings, March 2009.
 - Building Science Digest 013: Rain Control in Buildings, August 2011.
 - Building Science Digest 104: Understanding Air Barriers, October 2006.
 - Building Science Digest 105: Understanding Drainage Planes, October 2006.
 - Building Science Digest 106: Understanding Vapor Barriers, April 2011.
 - Building Science Insights 001: The Perfect Wall, July 2010.
 - Building Science Insights 084: Forty Years of Air Barriers – The Evolution of the Residential Air Barrier, February 2015.
4. *Handbook of Fundamentals*, American Society of Heating, Refrigeration and Air Conditioning Engineers, Inc., Atlanta, GA, 1997.
5. *International Building Code*, International Code Council, Country Club Hills, IL, 2015.
6. *International Energy Conservation Code*, International Code Council, Country Club Hills, IL, 2015.
7. *International Residential Code*, International Code Council, Country Club Hills, IL, 2015.
8. NFPA 285: *Standard Fire Test Method for Evaluation of Fire Propagation Characteristics of Exterior Non-Load-Bearing Wall Assemblies Containing Combustible Components*, National Fire Protection Association, Quincy, MA, 2012.
9. "Thermal Insulation, Environmental Acoustics," Volume 04.06, *Annual Book of ASTM Standards*, American Society for Testing and Materials, West Conshohocken, PA, November 1998.
10. *Specification for Masonry Structures* (TMS 602-16), The Masonry Society, Longmont, CO, 2016.
11. *Standard Method for Determining the Sound Transmission Rating for Masonry Walls* (TMS 0302), The Masonry Society, Longmont, CO, 2012.
12. *Standards for Architectural Cast Stone* (TMS 404, 504, and 604), The Masonry Society, Longmont, CO, 2016.